

Nuclear Strategies Project

**Modeling and Comparison of Options for the Disposal of
Excess Weapons Plutonium in Russia**

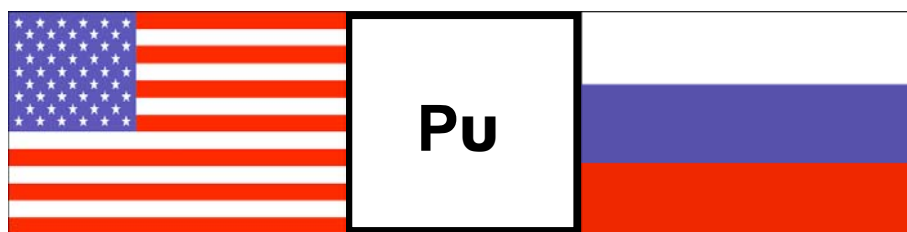

by

**Chel Stromgren
Project Manager
Science Applications International Corporation**

April 2002

Forward

Several relevant questions about the security of excess weapons-grade plutonium in the former Soviet Union have arisen in the post-Cold War period. How this material is guarded and eventually disposed of is of paramount concern to the U.S., if not the world.

The Advanced Systems and Concepts Office of the Defense Threat Reduction Agency tasked the Center for Nuclear Strategies, Science Applications International Corporation (SAIC), to examine disposition options of excess-weapons grade plutonium in Russia.

The Center assists U.S. and foreign government agencies in the development of modeling tools for analysis and strategic planning of nuclear issues through a program called the Nuclear Strategies Project (NSP). An important component of the NSP is the use of interactive system dynamics models. These models are periodically presented to senior level technical professionals and policy makers alike in a workshop format for discussion and real-time policy analysis.

The **Russian Plutonium Disposition Model** was built following a series of discussions and a few workshops with some of our nation's leading policy and technical experts. In particular, a DTRA/NSP Workshop was held on April 18, 2001 to discuss Russian disposition issues. The DTRA meeting followed a preliminary workshop held at the Center for Strategic and International Studies (CSIS) on Feb. 14, 2001.

The analysis presented here is based on a set of assumptions concerning nuclear policy in Russia presented to us over the past year. While many of the parameters in the model represent our best effort in obtaining the most accurate information available, they may need to be modified to reflect change over time. Suffice to say, the following report is not intended to be a "how to" manual for policy decision makers, but rather serve as a guide to considering some important issues at hand.

The systems dynamics modeling methodology employed has proven to be an effective tool for getting to the heart of issues. One reason is that the interactive nature of the model presents an opportunity for experts to see their assumptions put to the test in real time. This leads to meaningful dialogue, insight, and understanding.

It is my sincere hope that this analysis will foster further discussions, explorations, and creative solutions into Russian disposition of weapons-grade plutonium issues, and perhaps even serve as a tool to bring U.S. and Russian delegates together in the future.

Last, but not least, this project would not have been possible without the foresight of Dr. Jay Davis, former Director of DTRA, as well as contributions from Drs. Tony Fainberg and Gerald Epstein.

A handwritten signature in black ink, appearing to read "V. H. Reis". The signature is fluid and cursive, with a prominent initial "V" and a trailing flourish.

Dr. Victor H. Reis
Director, Center for Nuclear Strategies
Science Applications International Corporation

Background

The fall of the Berlin Wall symbolized the end of the Cold War and the beginning of a new era of cooperation between the U.S. and Russia. In the following years, the two military powers reached a consensus that maintaining a weapons buildup once necessitated by post World War II politics was no longer needed. Each side conceded the need to draw down excess military weapons.

The 1990s brought several important U.S.-Russian exchanges regarding each country's stockpile of excess weapons-grade plutonium (and highly-enriched uranium.) These discussions paved the way for a bilateral agreement regarding the disposition of weapons-grade plutonium announced by former U.S. President Bill Clinton and Russian President Vladimir Putin during a Moscow Summit Meeting in June of 2000.

The agreement calls for the irreversible disposition of no less than 34 metric tons of weapons-grade plutonium by each country. Disposition methods include irradiation of disposition plutonium as fuel in nuclear reactors, immobilization, and/or any other methods deemed agreeable by both countries. Construction and/or modifications needed to begin disposition operations should be completed by the end of 2007, and no less than 2 metric tons per year should be disposed of thereafter. Finally, collaborative efforts with other countries should be considered as a means to increasing the disposition rate.

The "Management and Disposition of Plutonium Designated as No Longer Required for Defense Purposes" agreement is viewed as a first step towards increased cooperation between the two military powers in the post Cold War era.

Introduction

The **Russian Plutonium Disposition Model**, built using system dynamics software (Stella or IThink), allows for analysis and comparison of different options for disposing of excess weapons-grade plutonium in Russia. The model permits users to consider different scenarios for storing and burning excess plutonium, providing estimates for the status of material, costs, revenues, and level of proliferation concern over time. (A detailed discussion of the *Russian Plutonium Disposition Model* operation is included in Appendix 1).

In this paper, the **Russian Plutonium Disposition Model** will be used to investigate three options for plutonium disposal: the use of existing Light Water Reactors (LWRs) converted to burn Mixed Oxide fuel (MOX), the building of new High Temperature Gas Reactors (HTGRs), and the building of new Advanced Fast Reactors (AFRs). The model is used to represent and analyze different scenarios involving these reactor types, as well as their associated fuel conversion and manufacturing facilities.

In order to provide a straightforward comparison of the capabilities of the different reactor technologies, the disposal scenarios analyzed in this paper are somewhat simplified compared to potential real-world scenarios. In this analysis, only one type of reactor is considered in each scenario and all changes in reactor capacity occur linearly. The model has the ability to simulate more complex scenarios involving multiple reactor types and reactor histories, however this analysis is reserved for future applications.

A major goal of this effort was to look at the performance of each scenario from both the U.S. and the Russian standpoint. The U.S. is primarily interested in reducing the proliferation threat posed by the excess plutonium. Meanwhile, the Russians see the excess plutonium as a valuable economic resource, from which they would like to generate energy and/or revenue. This model attempts to look at the future situation from each of these viewpoints, calculating estimates for both proliferation concern and revenue generation.

For each disposal scenario, the model tracks the quantity and state of excess plutonium through the entire fuel cycle. Using estimated performance parameters for the different reactor types, the model predicts the rate at which plutonium is burned, the amount of plutonium that remains in the form of waste at the end of the cycle, and the power generated through the burning of the plutonium.

The model then uses these performance results to calculate the total state and volume of plutonium that exists in the cycle and, based on the resources available to protect and guard that material, estimates the total level of concern

that the material poses. The calculated level of concern is a function of the amount of plutonium that exists, the relative “threat” posed by the material, and the level of safeguards that are applied to protect it. In this model, the threat of different material types is represented by a material concern index. The concern index is a weighting factor based on the relative difficulty of turning material back into a weapon. The concern indexes are specified on a scale of zero to one, with one being the most dangerous and zero the least dangerous.

The safeguards applied to materials are represented as a separate safeguard weighting factor. Safeguard factors are presented on a scale of zero to one, with one being fully protected and zero indicating no protection. Three separate levels of protection are specified in this model. The greatest protection is designated as “high-safeguards”, with a protection level of 0.99 selected for this model. This level of protection is equivalent to those provided at a Pantex type facility. The second level of protection is designated as “moderate-safeguards”, with a protection level of 0.8 selected for this model. The lowest level is designated “low-safeguards” and represents little or no protection, with a weighting factor of 0.0. The amount of material that can be protected at each level of safeguards is specified as an input to the model. The model automatically assigns the available safeguards to the material, placing the highest levels of protection on the most dangerous materials.

The level of concern for each material type is calculated as the product of the amount of material, the concern index, and one minus the safeguard factor. The values for each material type are then summed to give a total level of concern. The level of concern is presented in units of “equivalent weapons”. This value represents the total number of weapons that could be constructed from material for which there is some risk of diversion. The level of concern should not be interpreted as a prediction of the number of weapons that will be diverted but rather as an index of the relative risk at any point in time.

The performance results from the reactor cycles are also used to drive an economic analysis within the model. This economic analysis estimates the approximate costs associated with the disposal and storage of the excess plutonium and the potential revenues generated from the burning of that plutonium. The estimated costs are divided into three categories: capital costs, processing costs, and storage costs.

Capital costs are calculated as a yearly amount based on the acquisition cost of the reactors and other facilities, the lifetime of the assets, and a potential interest rate. The model includes the capital costs in the economic analysis only for the period when excess plutonium is being disposed of. This is done so that only costs directly linked to the plutonium are considered.

Processing costs are calculated for each processing step: conversion, fuel manufacturing, and burning. Per unit costs are specified for each process and reactor type. Total processing costs are calculated as the product of the amount of material processed and per unit cost.

Storage costs are also estimated on a per unit material basis. Per unit costs are determined by the level of safeguards that are applied. The material storage costs are calculated over the life of the simulation. All per unit costs in this model are based on the quantity of plutonium not the total quantity of material or waste.

Revenues in the model are estimated based on the reactor capacity that is specified and a constant electricity price. The sale price used in this model is a typical per kilowatt value averaged for residential and commercial use in Western Europe and Russia. It should be noted that this number is a very rough approximation and is highly volatile. In addition, the Russian energy market is not entirely open. Some of the generated power might be used internally and not sold while some might be sold at much lower rates. The revenue value predicted in the model should not be taken as an estimate of money that will be generated through power production but rather as an estimate of the value that could be derived from the plutonium.

The performance variables, costs, and safeguard data used in this model, detailed in Table A.1 in Appendix A, have been collected from a variety of industry sources. Reactor performance values are derived from detailed system dynamic models of reactor operation built in conjunction with Argonne National Laboratories. Cost and revenue variables are derived, as much as possible, from available industry literature. In many cases, however, values are “best-guess” estimates.

Scenarios

The model is initiated by specifying a particular scenario for analysis. Each scenario is defined by a set of input variables. These variables include:

- Quantity of excess plutonium to be disposed of
- Reactor type used
- Reactor capacity and time history
- Fuel manufacturing capacity and time history
- Level of material protection safeguards available

Three baseline cases were investigated for this paper. This first involves the disposition of approximately 35 tonnes of excess weapons plutonium in Russia, the amount specified in U.S.–Russian plutonium disposition agreements. The second and third baselines each investigate the disposition of 185 tonnes of excess weapons plutonium. This amount is an estimate of the total amount of excess plutonium that currently exists in Russia. The second baseline case

assumes that the Russians will only release the additional 150 tonnes of plutonium for use if a fast reactor cycle is used. In this case the 150 tonnes remains in storage if either the LWR or HTGR is selected. In the third baseline, all 185 tonnes of material is available for burning in any reactor type. For each baseline case, four different scenarios for the disposal of excess plutonium scenarios are analyzed and compared:

- 1) Store material indefinitely
- 2) Burn available excess material using existing LWRs converted to MOX
- 3) Burn available excess material using new HTGRs
- 4) Use all excess material as seed fuel in new AFRs

The input variables for each Baseline case are detailed in Table 1:

	Baseline A	Baseline B	Baseline C
Initial Excess Plutonium	35 tonnes	185 tonnes	185 tonnes
Available to burn in LWR	35 tonnes	35 tonnes	185 tonnes
Available to burn in HTGR	35 tonnes	35 tonnes	185 tonnes
Available to burn in AFR	35 tonnes	185 tonnes	185 tonnes
Disposal Scenario 1	Indefinite Storage	Indefinite Storage	Indefinite Storage
Disposal Scenario 2	10 GWe LWR-MOX	10 GWe LWR-MOX	10 GWe LWR-MOX
Disposal Scenario 3	5 GWe HTGR	5 GWe HTGR	10 GWe HTGR
Disposal Scenario 4	5 GWe AFR	26 GWe AFR	26 GWe AFR
High Safeguard Capacity	15 tonnes	80 tonnes	80 tonnes
Moderate Safeguard Capacity	20 tonnes	105 tonnes	105 tonnes

Table 1: Baselines Cases

The distinction between the baseline cases is an important part of this analysis. While past discussion has centered on the 35 tonnes of immediate concern, it is important to consider the effect of the rest of the plutonium stockpile on both the level of concern and the power produced from the plutonium. The various scenarios investigated produce significantly different results for each of these baseline cases.

When investigating the cases with the additional 150 tonnes of excess plutonium, it becomes important to consider Russian policy concerning the additional material. It is possible that the Russians will be willing to release only the 35 tonnes specified in agreements for burning in either LWRs or HTGRs. This possibility is based on the feeling expressed by the Russians that they want to use their excess plutonium as seed fuel for a long-term, fast reactor based, power generation program. In this case, as in the second baseline, only 35 tonnes of material would be sent to either the LWR or HTGR for burning. The remaining 150 tonnes of excess plutonium would only be available for burning with an AFR option.

The model is configured to handle this question. There is a switch included in the model that sets Russian policy on the 150 additional tonnes. If this switch is on, the Russians will release all of the plutonium to whichever reactor type is selected. If it is off, then only the 35 tonnes would be released for burning in LWR or HTGR cycles, any additional material would only be released with the AFR option.

The results for each of the baseline cases are discussed below:

**Baseline A: Consider 35 Tonnes of Excess Plutonium
All Plutonium Available for Burning in Each Cycle
15 Tonnes of High-Safeguard Storage Available
20 Tonnes of Moderate-Safeguard Storage Available**

Scenario 1: Indefinite Storage

**Scenario 2: 10 GWe LWR w/ MOX
Start Burning in 5 Years, 20 Year Life**

**Scenario 3: 5 GWe HTGR
Start Burning in 10 Years, 40 Year Life**

**Scenario 4: 5 GWe AFR
Start Burning in 20 Years, 40 Year Life**

In the first baseline, in which only 35 tonnes of material are considered, the level of reactor power considered for each option was selected to burn-down the excess plutonium in a reasonable amount of time.

The capacity for the LWR-MOX option is based on plans that have been proposed by Russia. In this case, approximately 10 GWe of existing LWR capacity would be converted for use in burning MOX fuel. The converted reactors would all operate with 1/3 of the core consisting of plutonium fuel. Reactor conversion would begin in 5 years and proceed at a rate of 2 GWe of capacity per year. Reactors would have an average operational lifetime of 20 years. In order to support these reactors, a conversion facility and fuel manufacturing facility with capacities to produce about 2.7 tonnes of MOX fuel per year are included in the model with this option.

The power level considered for the HTGR option was selected to achieve a burn-down rate for the plutonium similar to that achieved with the LWR-MOX option. In this case an HTGR capacity of 5 GWe was considered. Conversion and fuel manufacturing facilities to produce 2.8 tonnes of HTGR fuel per year are included in the model in this case. It was assumed that the HTGR reactor construction would begin after 10 years at a rate of 2 GWe per year and that the reactors would have a 40-year operating life.

For the AFR, the model has the capability to consider reactors with various fuel conversion ratios. For this analysis, a conversion ratio of 1.0 is considered.

Because only plutonium flows into and out of the reactor are considered in this model, the fuel reprocessing and re-loading are not modeled. These functions are considered to be part of the reactor cycle. At a conversion ratio of 1.0, only an initial load-up of plutonium is required to begin reactor operation. No make-up feed is required for continued reactor operation and no plutonium in waste exits the reactor.

A level of reactor power was selected for the AFR option that would dispose of all of the excess plutonium in the initial load-up of the reactor capacity. In this case, 5 GWe of AFR capacity was used at an initial load-up of 7 tonnes/GWe. To produce the fuel for the reactors, a fuel manufacturing facility was modeled with a capacity of 7 tonnes/year. It would begin operation 5 years before the reactors would come on-line. It was assumed that AFR construction would start in 20 years at a rate of 2 GWe/year and that reactors would have a 40-year operating life.

In all of the scenarios for the first baseline, it is assumed that the Russians have limited capacity to provide safeguards for plutonium. The total volume of plutonium, in any form, that can be protected with high-safeguards, roughly equivalent to Pantex level protection, is 15 tonnes. The total amount of material that can be protected at moderate safeguards, equivalent to IAEA level protection, is 20 tonnes. The selected levels of safeguard capacity ensure that all plutonium will be protected at moderate or high levels and that no material will remain protected at low safeguards.

The selection of these safeguard levels for the analysis is somewhat arbitrary. An assumption was made that the Russians were likely to protect some but not all of the material at high-safeguards but also would not leave any material unprotected with low safeguards. It is likely that a more optimal mix of safeguards could result a more beneficial mix of threat reduction and costs. However, the actual safeguard levels selected do not impact the general trends investigated in the model.

The results for the first baseline demonstrate the inherent differences in the operation of the reactor cycles and in the time that the technology would be available. First, looking at the state of material over time, Graph 1 shows the total amount of excess separated plutonium and plutonium in fuel in the system. Using the LWR-MOX option, the entire 35 tonnes is burned down in 21 years. The HTGR burns down at a similar rate but because it would not begin operation until 5 years after the LWR, it would take 24 years to burn down the entire stock. The results for the AFR are quite different. Because the reactors would not begin operation until 20 years, the entire 35 tonnes would remain until that time. All of the plutonium would be loaded into the reactors by year 23.

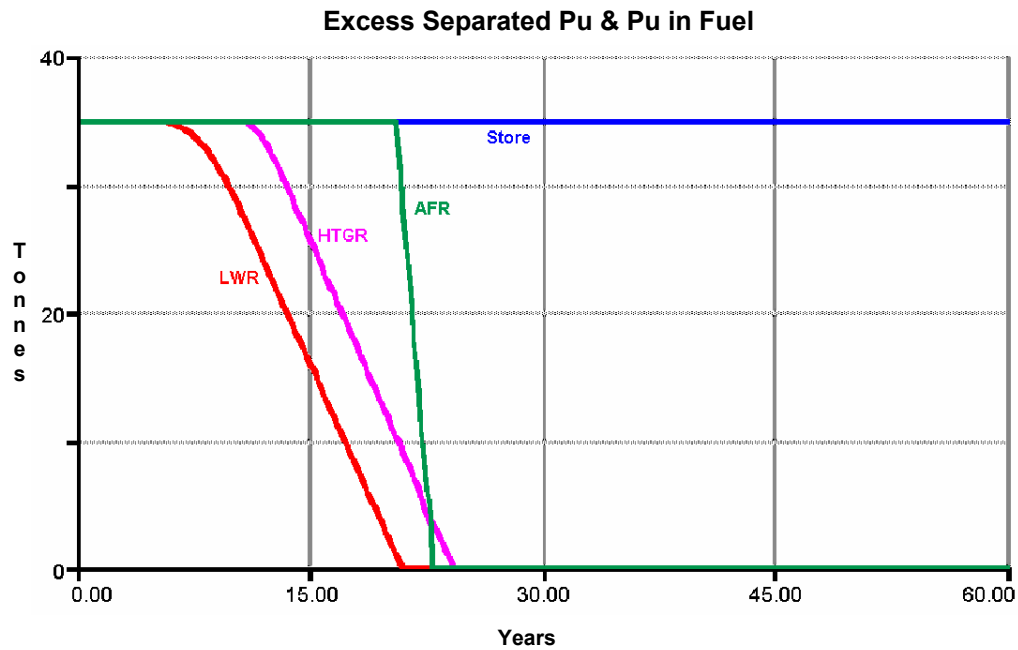

Graph 1: Plutonium Disposal – Baseline A

The amount of plutonium that exits the reactors in the form of waste is also significantly different for each reactor cycle. Graph 2 shows the total plutonium in waste that is produced by the reactors. The LWR reactors, because of their relatively high discharge fraction, produce 12.2 tonnes of plutonium in waste from the 35 tonnes burned. The HTGR, with a lower discharge fraction, produce only 3.5 tonnes of plutonium in waste. The AFR, at a conversion ratio of 1.0, in which the plutonium being unloaded from the reactor is reprocessed into fuel, produces no plutonium in the form of waste.

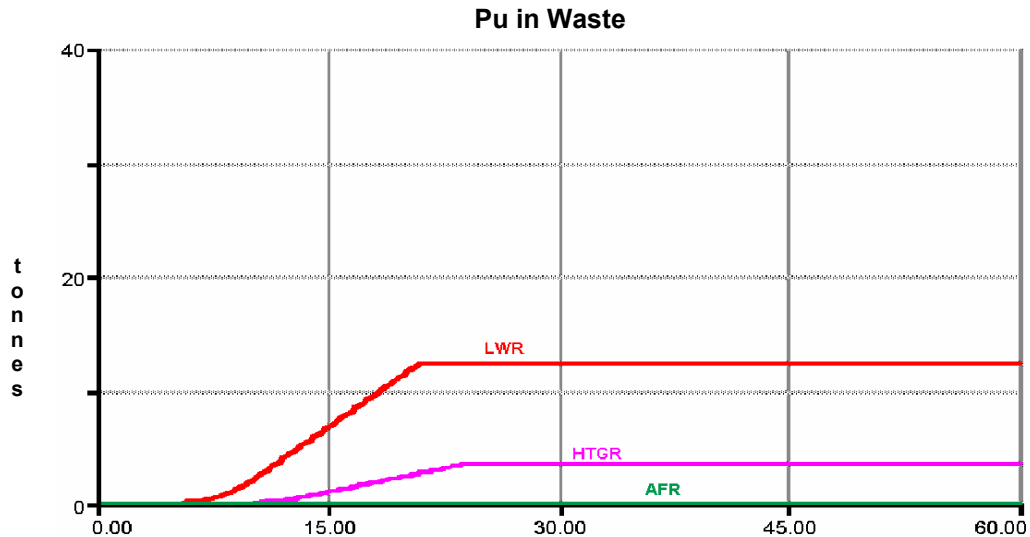

Graph 2: Plutonium in Waste – Baseline A

Years

The time that it takes for excess plutonium to be converted into fuel and burned and the total amount of plutonium that must be stored as waste are contributing factors to the total level of concern over that material. The model calculates this level of concern based upon the volume of the material, the state of the material, and the level of protection that can be applied to protect the material. Graph 3 shows the level of material concern over time for the four scenarios considered. The results presented in this graph reflect the burn-down of the plutonium shown in Graph 1. If the material is stored indefinitely, with 15 tonnes in high-safeguard storage and 20 tons in moderate safeguard storage, there is a constant concern of 207.5 equivalent weapons (e-w). The LWR option most quickly reduces the level of concern over this plutonium and results in a residual concern level of 0.612 e-w, due to the remaining plutonium in the form of waste. The HTGR option reduces the level of concern after a delay due to the reactor starts and brings the residual level down to 0.175 e-w. The AFR option brings the level of concern down more slowly but results in 0 residual concern¹.

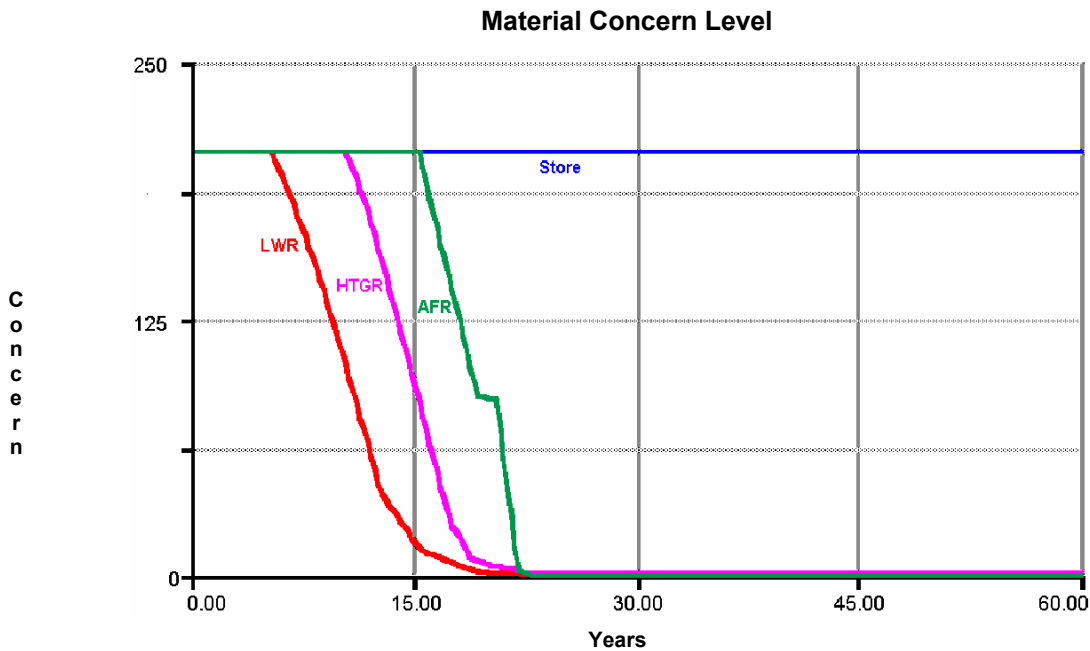

Graph 3: Weighted Material Concern – Baseline A

¹ It is assumed for this analysis that there is no risk of diversion for material inside of a reactor, i.e. the level of protection for this material is 1.0

A better way to interpret the significance of the concern is to integrate the instantaneous concern level shown in Graph 3 to a total concern level over time. This result is shown in Graph 4. In this plot the level of concern, measured in equivalent weapon-years grows over time, based on the level of concern that have occurred throughout the simulation. These results are particularly significant because they capture the impact of not only the instantaneous levels of concern, but also of the time it takes to reach reduced levels of concern.

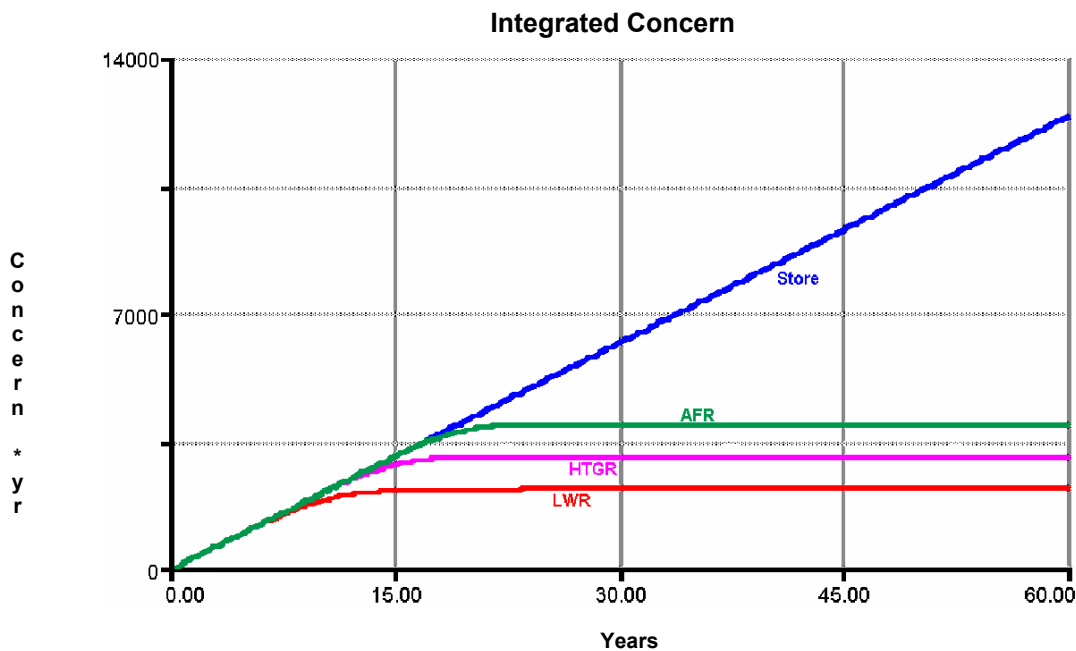

Graph 4: Integrated Material Concern – Baseline

The results show that if material is simply stored at the specified protection levels after 60 years there will have been a total of 12,450 weapon-years of concern. The implementation of an LWR-MOX strategy reduces this level to 2,150 weapon-years. The HTGR option reduces the integrated concern to 3,520 weapon-years and the AFR option reduces the integrated concern to 3,900 weapon-years. The difference in total concern between the three reactor options is primarily a function of the time that it takes to put the technology into place. Because separated excess material continues to be stored until reactors are ready, a high integrated level of threat builds up. It should be noted, however that compared with indefinite storage option, all three reactor options significantly reduce the total concern level.

While concern of weapon proliferation is of primary importance to the United States, the Russians are more interested in the economic prospects of the various options, particularly in how the excess plutonium is exploited to produce energy and perhaps revenue. Graph 5 compares the three reactor options on the basis of the amount of revenue that can potentially be generated from the excess plutonium. This revenue is derived from the electrical generating capacity of the nuclear plants used to burn the plutonium.

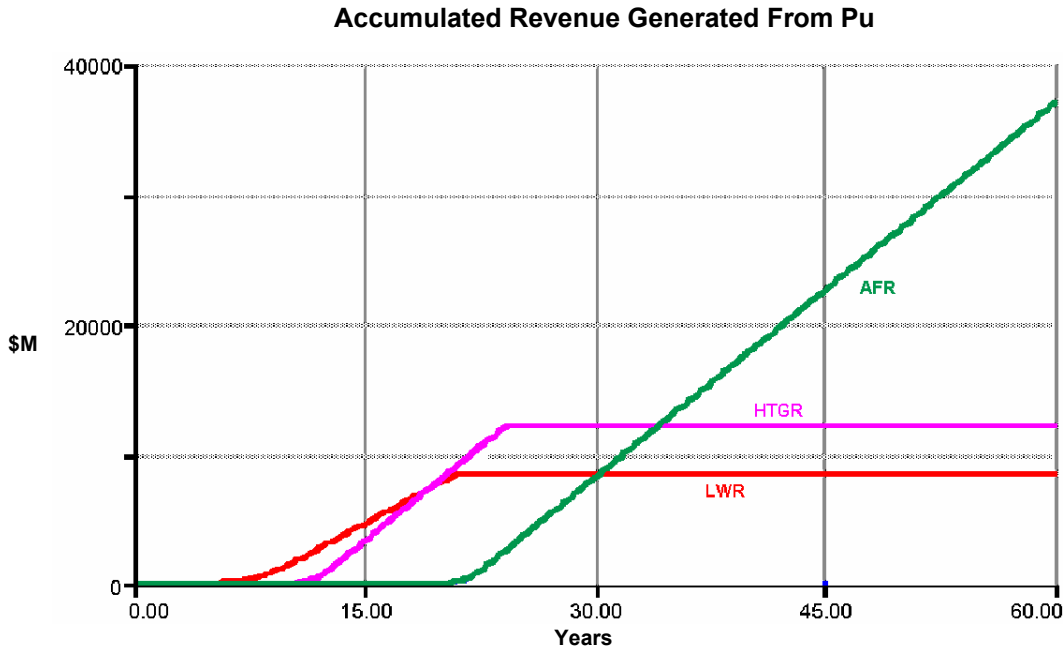

Graph 5: Revenue generated From Plutonium – Baseline A

The capacity is multiplied by a constant power tariff of \$193M/GWe-year. This tariff is based on average industrial and residential power costs for the past five years in Russia and Western Europe. This value is provided as a measure to compare the output of various reactor options rather than an actual prediction of revenues. The price and market for electricity in Russia is highly volatile, making predictions difficult.

In cases where the reactor's operating life is longer than the time required to burn all of the subject excess plutonium, only revenues generated during the plutonium burn period are accounted for. In the case of the LWR-MOX option, only a portion of the electricity generated proportional to the core fraction consisting of MOX is counted towards revenue. In the case of the AFR, where the excess plutonium is used as seed fuel to begin reactor operation and plutonium in waste is reprocessed to continue operation, the entire lifetime energy production of the reactors is considered.

Graph 5 shows the accumulated revenues generated from the plutonium for the three reactor options. The LWR-MOX, which derives one-third of its 10 GWe capacity from the plutonium, burns the plutonium down in 21 years and produces \$8.4B in revenues from the plutonium. The HTGR, with its greater efficiency, produces its entire 5 GWe capacity from plutonium for 24 years and produces \$12.2B. The AFR, which seeds 5 GWe of capacity with the 35 tonnes of plutonium, will generate electricity for its 40-year lifetime, resulting in \$37.2B in potential revenue.

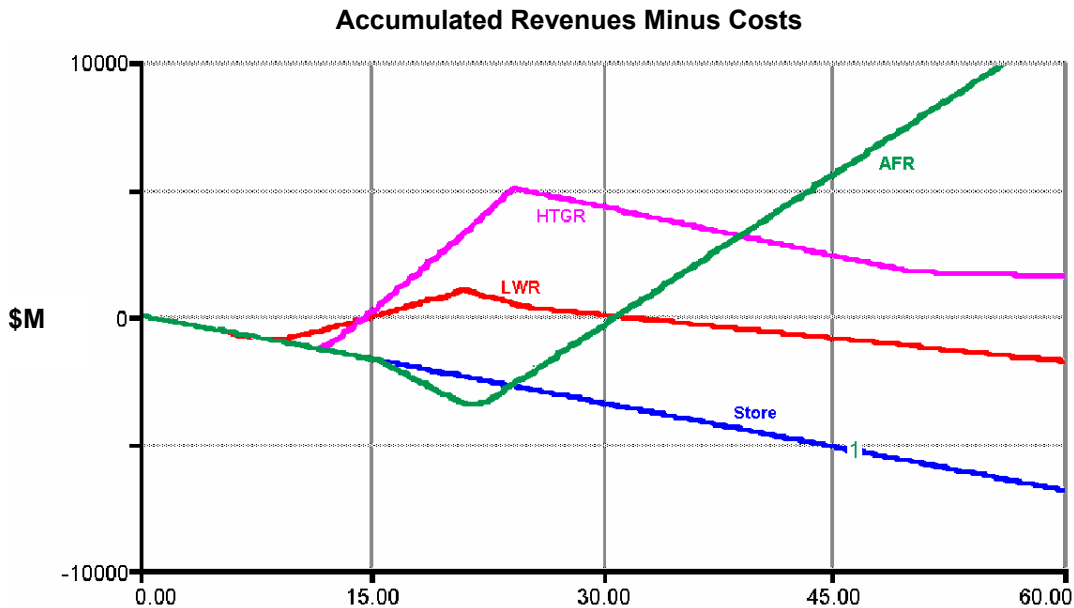

Graph 6: Total Earnings – Baseline A

The potential revenue from the reactor capacity is only one-half of the economic equation that must be considered. The costs associated with the power generation should also be looked at. The costs calculated in this model include three separate parts: the capital costs of facilities, the processing cost of creating and burning, and recycling fuel, and the storage cost for material.

These three costs are summed and subtracted from the revenues produced to produce a cash flow value. The cash flow is then integrated over time to give total earnings for the scenario. These total earnings are shown in Graph 6 for the three reactor options plus the indefinite storage option.

The storage option results in no revenue and a constant cost to store the material over time of \$115M per year. The resultant earnings at the end of the 60-year period are therefore -\$6.9B. Using the LWR-MOX option, storage costs are incurred for all of the material until the reactor opens in year 5 and for any

material remaining in the system for the life of the simulation. Revenues are generated from the reactor opening in year 5 until the plutonium is burned in year 18. The total earnings at the end of the 60-year simulation for the LWR-MOX are -\$1.7B. For the HTGR option, the total earnings at the end of 60 years are \$1.6B. The positive earnings reflect the significantly greater revenues generated by the HTGR and the lower amount of plutonium in waste that must be stored. The AFR option results in a lifetime earnings of \$12.6B. In this case, the much greater earnings are due again to the long-term revenues and the lack of any requirement for waste storage.

Baseline B: Consider 185 Tonnes of Excess Plutonium
35 Tonnes Available for Burning in LWR or HTGR
All Material Available for Burning in AFR
80 Tonnes of High-Safeguard Storage Available
105 Tonnes of Moderate-Safeguard Storage Available

Scenario 1: Indefinite Storage

Scenario 2: 10 GWe LWR w/ MOX
Start Burning in 5 Years, 20 Year Life

Scenario 3: 5 GWe HTGR
Start Burning in 10 Years, 40 Year Life

Scenario 4: 26 GWe AFR
Start Burning in 20 Years, 40 Year Life

In the second baseline case, 185 tonnes of excess plutonium is considered in the model. 35 tonnes of the material is available for burning in any reactor cycle. An additional 150 tonnes will be burned only in an AFR cycle. Excess material that is not available for burning will be stored indefinitely. The capacities for the LWR-MOX and the HTGR options remain the same as in Baseline A, since these options will still deal only with 35 tonnes of material. The capacity of the AFR option is increased to 26 GWe. This is the capacity that can be initially seeded for operation with 185 tonnes of excess plutonium.

Graph 7 shows the total amount of plutonium remaining as excess separated material or in fuel for each option. With the same reactor capacity as in Baseline A, the LWR-MOX and HTGR options have the same plutonium burn-down rate for the initial 35 tonnes. However, since only this portion of the material will be released for burning, the reactors can only burn-down the excess material to a level of 150 tonnes. The AFR however will use all of the available material in 33 years. The levels of plutonium in the form of waste produced by each option in this baseline case are the same as for baseline A, shown in Graph 2.

The level of concern over the plutonium reflects the amount of excess material that remains in the system. Graph 8 shows the level of concern over time for each option. The indefinite storage option has a constant concern level of 1090 equivalent weapons for the 185 tonnes of excess material. The LWR-MOX and the HTGR reduce the level of concern to approximately 750 equivalent weapons in 21 and 24 years, respectively. The remaining 150 tonnes of material, which

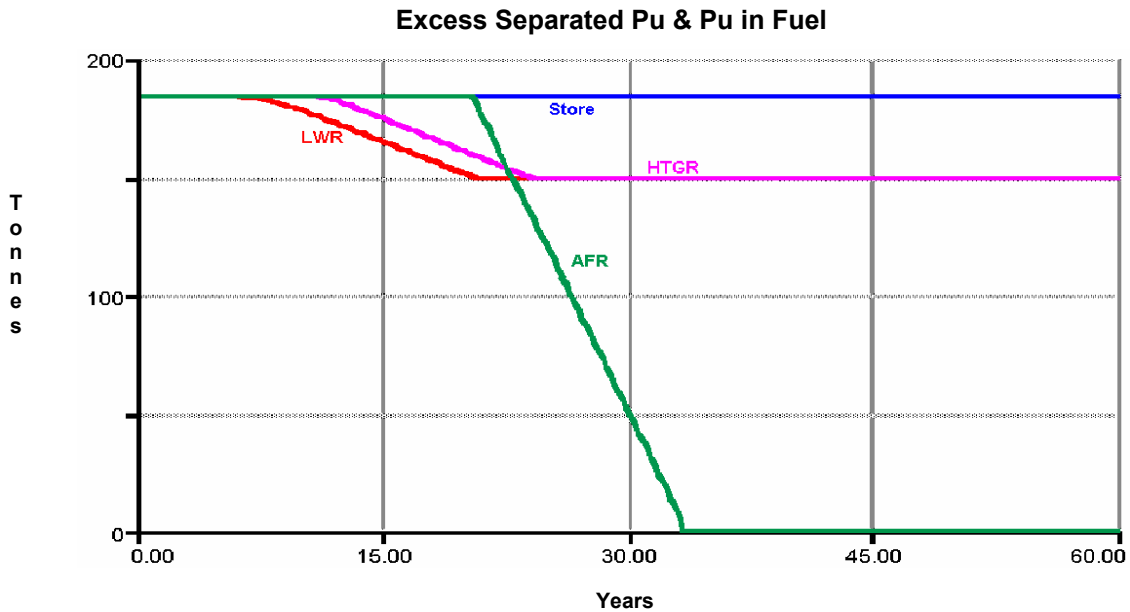

Graph 7: Plutonium Disposal – Baseline B

must be stored, keep the concern at this level indefinitely. The AFR option begins to reduce the threat level after 15 years as the separated material is converted into fuel and then reduces the threat level to zero when the reactors are loaded by year 33.

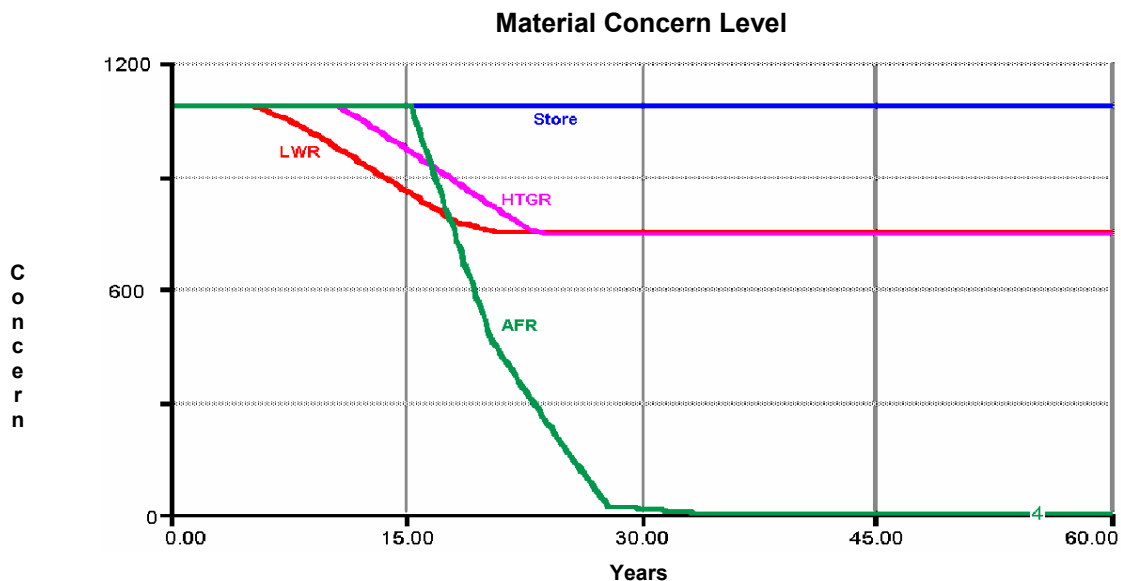

Graph 8: Weighted Material Concern – Baseline B

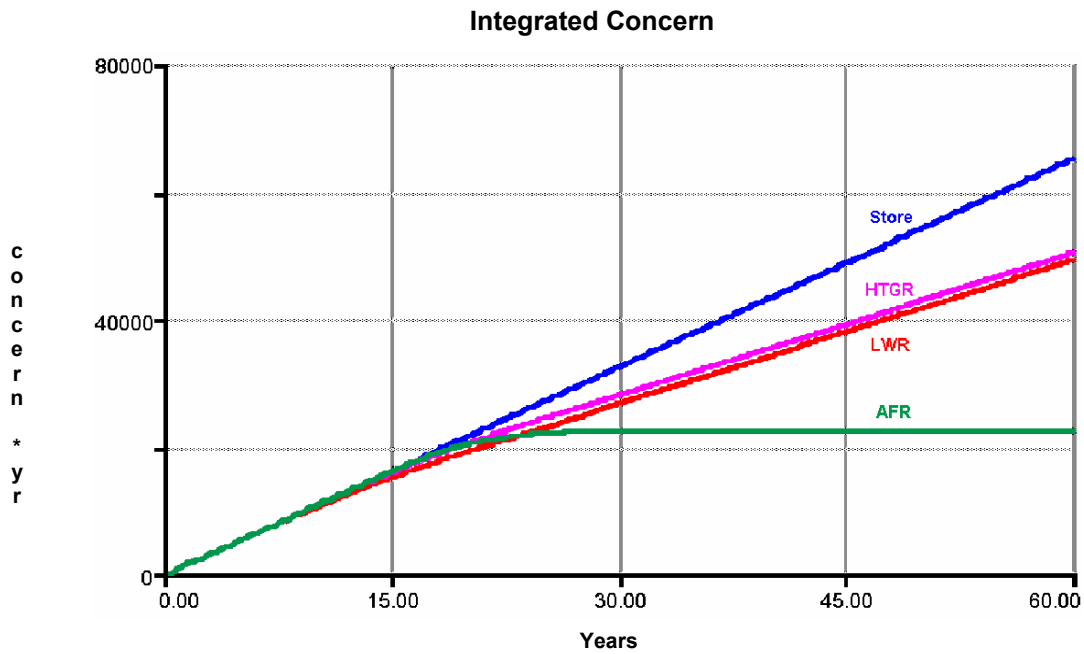

Graph 9: Integrated Material Concern – Baseline B

Graph 9 then shows the material concern level integrated over time. Because in the storage, LWR-MOX, and HTGR options, large amounts of excess material are stored indefinitely, concern is continuously accumulated. The indefinite

storage option results in a total concern of 65,400 equivalent weapon-years. The LWR-MOX results in 49,000 equivalent weapon-years, and the HTGR results in 50,400 weapons-years. With the AFR integrated concern levels grow only until the initial loading of material is completed in year 33, resulting in a total concern level over the next 60 years of only 22,300 equivalent weapon-years.

The potential revenues generated for the cases in Baseline B are highly dependent on the volume of plutonium available for burning. These results are shown in Graph 10. In these scenarios the revenues generated by the LWR-MOX and the HTGR are the same as for Baseline A, \$8.4B and \$12.2B, respectively. The revenues generated by the AFR are much greater, however, \$169B, reflecting the increased capacity that can be seeded from the greater available material quantity.

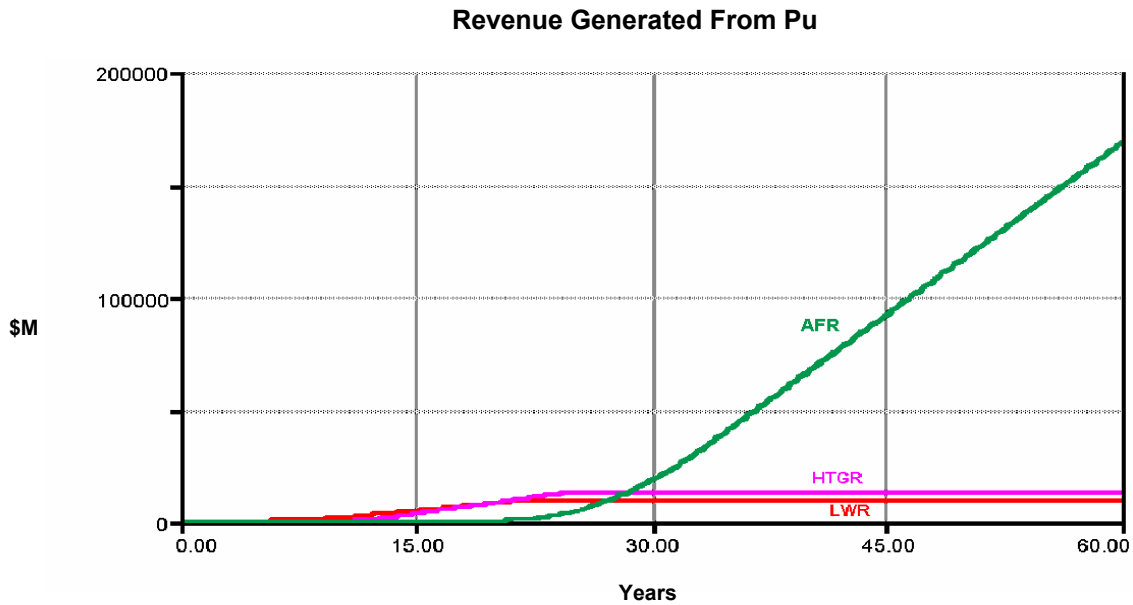

Graph 10: Revenue generated From Plutonium – Baseline B

The total earnings for each of the cases include the costs for long-term storage of the material. These costs are reflected in the results shown in Graph 11, the total earnings. Because of the significant storage costs, the earnings for the storage option, the LWR-MOX and the HTGR are all negative. The storage option results in total earnings of -\$36.6B. The LWR-MOX has total earnings of -\$31.8B. The HTGR option results in total earnings of -\$29.4B. The AFR option, with its lower storage costs and greater profits, results in total earnings of \$55.8B.

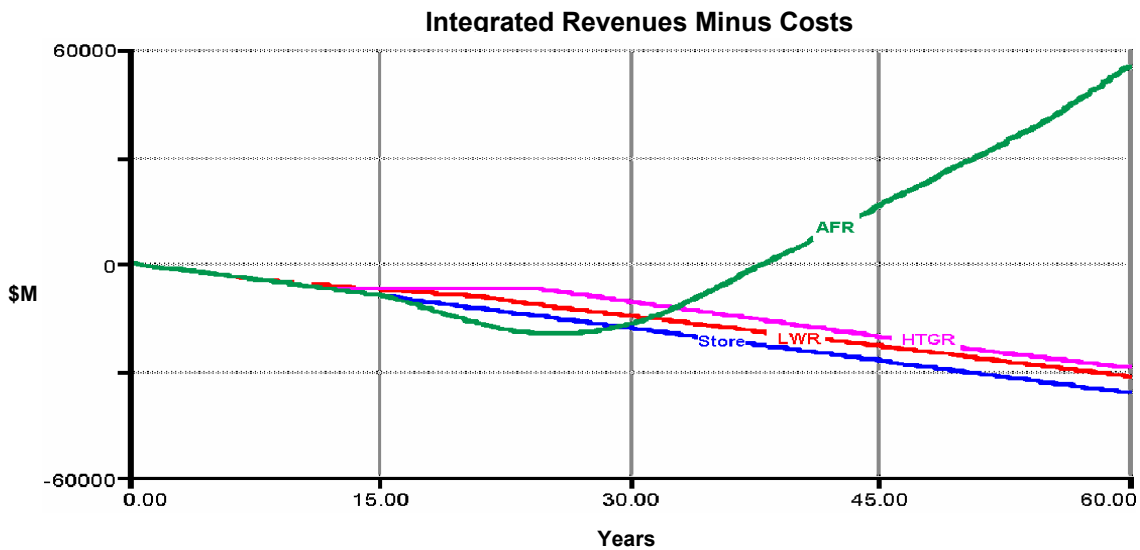

Graph 11: Total Earnings – Baseline B

In some ways, it is somewhat misleading to compare the results from the different reactor scenarios in this baseline case, since for each option, except the AFR, storage costs are being calculated for material that cannot be burned.

However, this baseline reflects the current feeling in Russia that the plutonium should be saved until it can be used to seed a long-term fast reactor. Because the material actually does exist and safeguards must be applied to protect it, the storage costs and total revenues reflect the reality of what costs must be endured.

Baseline C: **Consider 185 Tonnes of Excess Plutonium**
 All Material Available for Burning in All Cycles
 80 Tonnes of High-Safeguard Storage Available
 105 Tonnes of Moderate-Safeguard Storage Available

- Scenario 1:** **Indefinite Storage**

- Scenario 2:** **10 GWe LWR w/ MOX**
 Start Burning in 5 Years, 20 Year Life

- Scenario 3:** **10 GWe HTGR**
 Start Burning in 10 Years, 40 Year Life

- Scenario 4:** **26 GWe AFR**
 Start Burning in 20 Years, 40 Year Life

The final baseline investigated for this report also considers a total of 185 tonnes of excess separated plutonium. However, in this, case, it is assumed that the Russians would release the entire stock of excess plutonium for burning, regardless of the reactor technology selected.

The reactor power levels for this baseline are similar to those for Baseline B. The LWR-MOX power level is kept at 10 GWe. The amount of plutonium being considered here could support a greater reactor capacity, however it would not be practical to develop a capacity much greater than 10 GWe. This option relies on converting existing LWR capacity to burn a partial MOX core. The amount of LWR capacity that currently exists in Russia that could be converted is limited. It is therefore not reasonable to consider greater capacities.

The HTGR capacity in this case was increased to 10 GWe. This power level was selected because it allows the stock of 185 tonnes of excess plutonium to be burned-down in approximately the lifetime of the reactors. The capacity for the AFR option remains at 26 GWe, the level that could be seeded by the 185 tonnes.

Graph 12 shows the amount of excess separated material and fuel which remain in the simulation for each option. The LWR-MOX reactors, which have a lifetime of only 20 years, cannot burn down the entire stock of excess material. In the 20 years of operation they burn approximately 55 tonnes of plutonium, leaving 130 tonnes in indefinite storage. The 10 GWe of HTGR capacity burns the full 185

tonnes of plutonium in 46 years. The AFR, as in Baseline B, disposes of all the material in year 33, when the reactors are loaded.

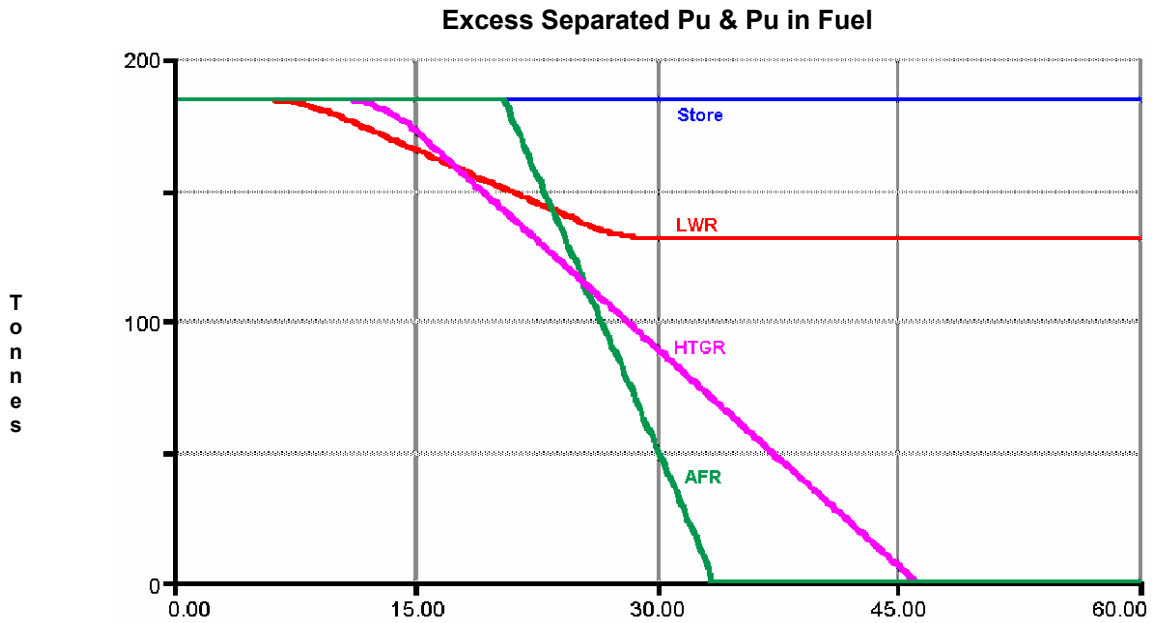

Graph 12: Plutonium Disposal – Baseline C

Graph 13 shows the resultant plutonium in waste that is produced from each scenario. The 55 tonnes of material burned in the LWR-MOX results in 19 tonnes of plutonium in waste. The 185 tonnes burned in the HTGR results in 18.5 tonnes of plutonium in waste. If the AFR option is selected, all plutonium is recycled, so no plutonium-bearing waste is produced.

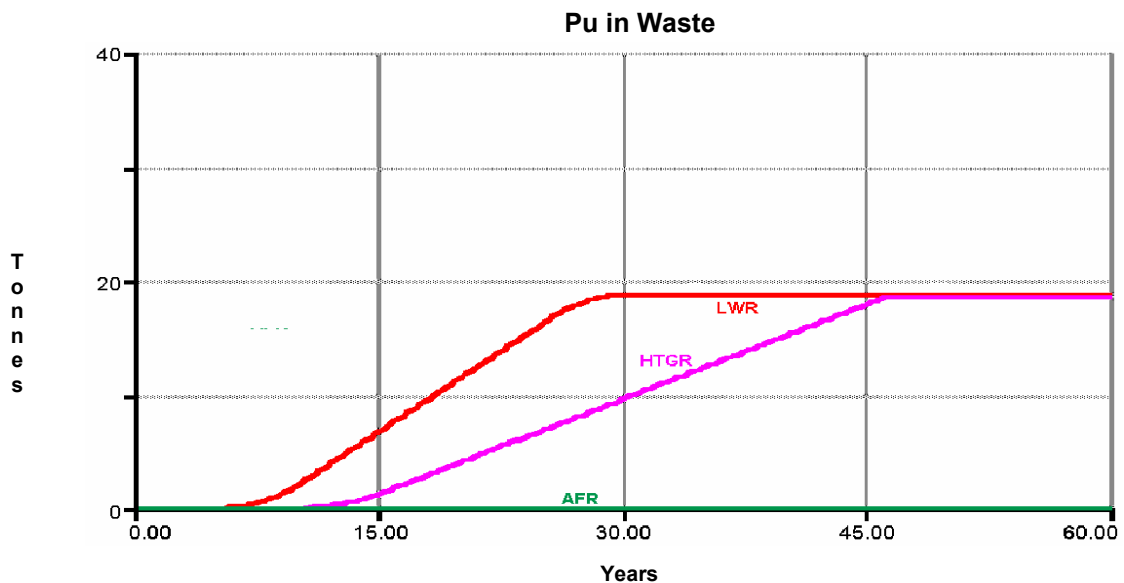

Graph 13: Plutonium in Waste – Baseline C

Graph 14 shows the level of concern of material for each scenario in Baseline C. As in Baseline B, indefinitely storing all 185 tonnes results in a concern level of 1090 equivalent weapons. Using the LWR-MOX option to burn down 55 tonnes of the material results in a residual concern of 560 equivalent weapons after 25 years. The HTGR continuously reduces the concern level over the life of the

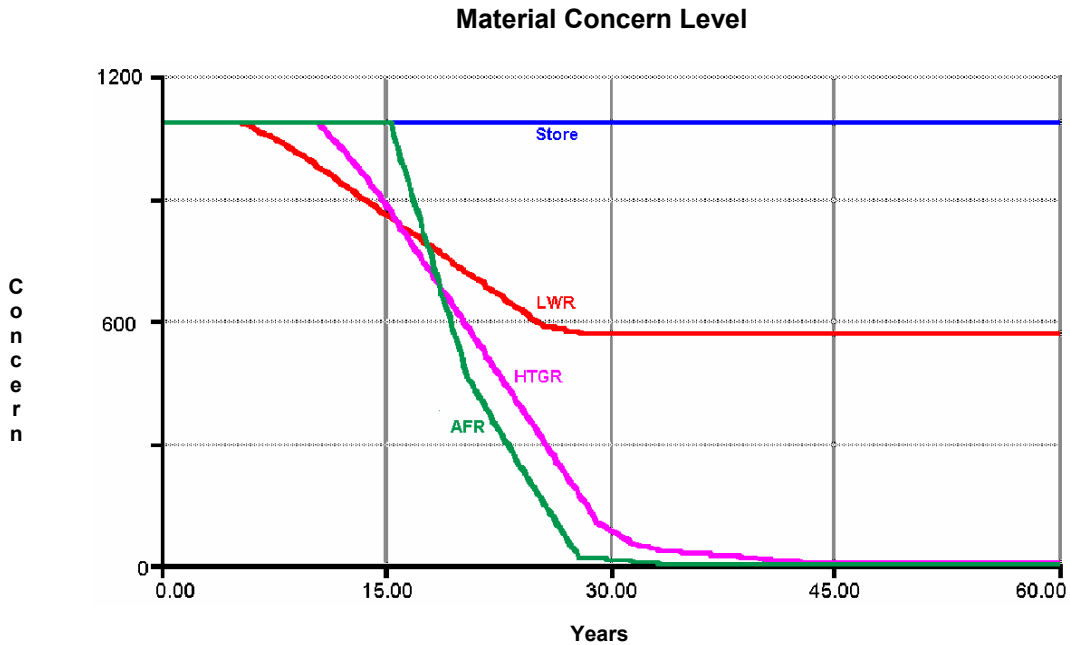

Graph 14: Weighted Material Concern – Baseline C

reactor, resulting in a residual concern of 1 equivalent weapon after 46 years. The AFR reduces the concern level to zero after 33 years.

The integrated concern levels, shown in Graph 15, reflect the residual levels shown above. The indefinite storage option again results in a total concern of 65,400 weapon-years. The LWR-MOX option result in a concern of 42,000 weapon-years. The HTGR and AFR options produce similar levels of concern. The HTGR, although it takes longer to dispose of the material, begins operation earlier and results in a concern of 23,200 weapon-years. The AFR option results in a total concern over the next 60 years of 22,300 weapon-years.

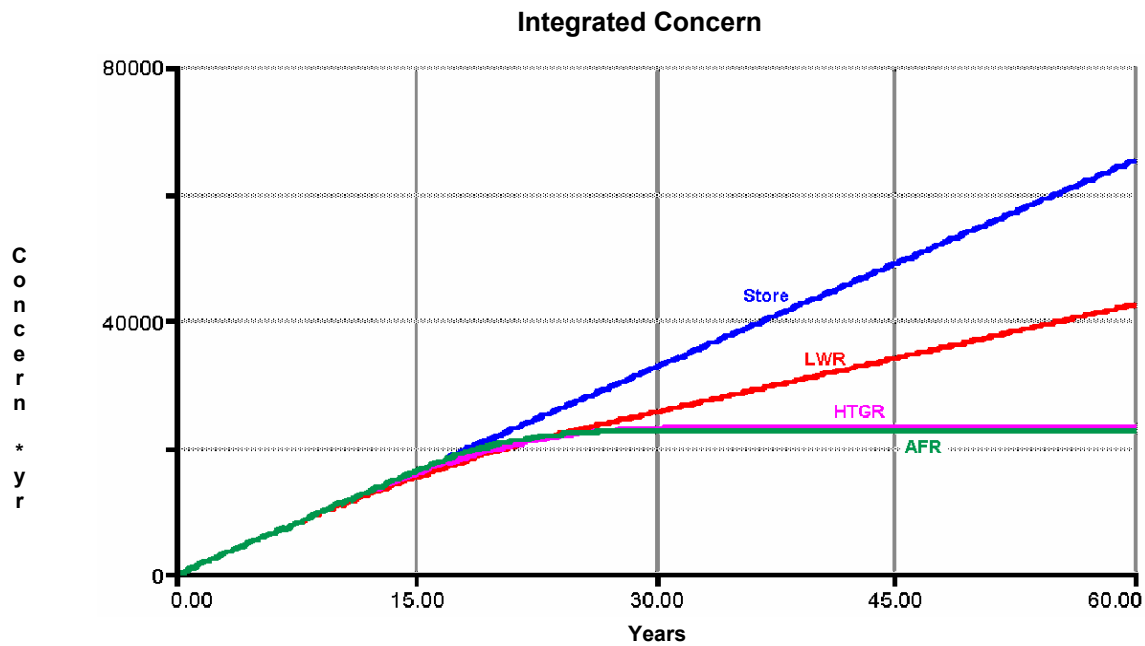

Graph 15: Integrated Material Concern – Baseline C

Analysis of the potential revenues generated for the scenarios in Baseline C demonstrate why the Russians are committed to only releasing the bulk of the excess plutonium for use in a fast reactor cycle. Revenues generated from the plutonium are shown in Graph 16. Significantly greater revenue is generated from the AFR than from other cycles. The LWR-MOX option, which is able to burn only a portion of the available material in its lifetime results in potential revenue generation of \$12.8B. The HTGR, which is able to generate power from all of the plutonium, produces potential revenues of \$64.3B. The AFR, which is able to produce significantly greater power from the same fuel, results in revenues of \$169B over the period of this simulation. The ability of the AFR to breed fuel from fertile material allows much greater revenues to be generated from the same initial amount of fissile fuel.

Revenues Generated From Pu

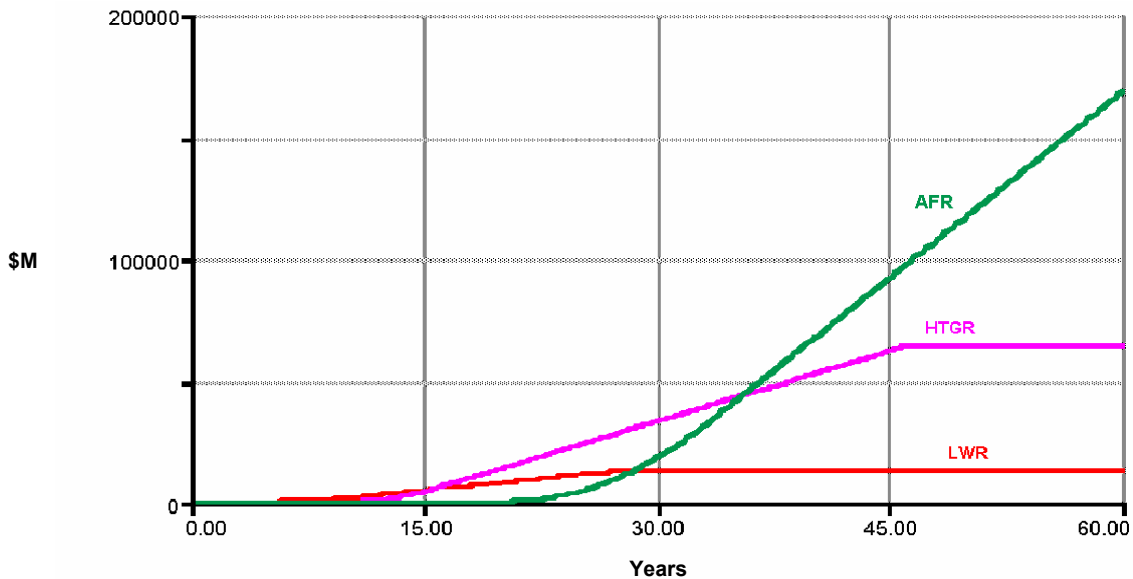

Graph 16: Revenue generated from Plutonium – Baseline C

The differences between the reactor cycles are demonstrated more dramatically in looking at the total earnings produced. These results are shown in Graph 17. It can be seen that either of the options that require long-term storage of excess plutonium result in significant negative earnings. The storage option again produces -\$36.6B. The LWR-MOX option produces earnings of -\$28.5B.

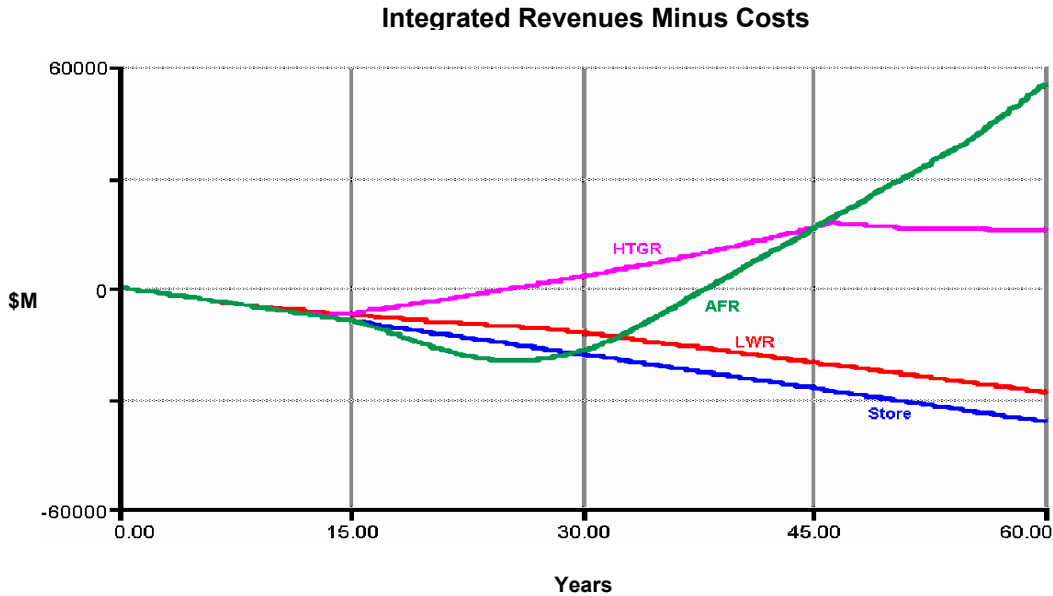

Graph 17: Total Earnings – Baseline C

If the excess material can be burned in a reasonable amount of time, significant earnings can be produced. The HTGR option produces total earnings over the next 60 years of \$15.6B. The AFR, because of the greater revenues, results in earnings of \$55.8B over the same time period.

Conclusions:

The results from this model analysis are indicative of the issues that must be addressed in forming policy to work with the Russians on reducing the threat posed by excess weapons plutonium. Policy must consider both the immediate and long-term impacts on proliferation. In addition, disposal plans must address not only U.S. concerns over the proliferation of material, but also must take into account the Russian desire to derive value from the excess material.

If the primary focus of concern for the U.S. is on reducing the threat posed by the 35 tonnes of excess separated plutonium that are currently on the table, then the conversion of existing Russian LWR's to the burning of MOX fuel is the best solution. The relatively quick availability of these reactors allows the excess Pu to be burned down quickly, reducing the associated level of concern.

However, if the U.S. is concerned with the “big picture”, that is we wish to consider the level of concern posed by the entire stock of excess Russian

plutonium, than the LWR-MOX option is not ideal. The limited availability of LWR capacity and the relatively slow burn-down rate would not allow the LWR option to dispose of the greater amount of material. Levels of concern would remain relatively high for an extended period of time.

In this case, both the HTGR and the AFR options produce better results (assuming that material would be released for burning in an HTGR). Because a greater capacity can be constructed using these new cycles and the operating lives would be longer, a much greater amount of material can be disposed of. Both of the options result in reduced long-term proliferation concern compared to the LWR option.

In looking at the potential economics of the different cycles, the results of this model show why the Russians are reluctant to simply burn excess material in a thermal reactor cycle. While significant revenues can be generated from the burning of the plutonium in thermal cycles, this value is small compared to the potential revenues derived from the seeding of AFR reactors with the same material. The initial 35 tonnes of material under consideration would produce approximately 60 GWe-years of power in a HTGR cycle using a 40-year reactor lifetime. The same material would produce over 200 GWe-years from an AFR cycle using the same reactor life. Alternatively, if we consider the entire 185 tonnes of material, using an HTGR cycle, about 10 GWe of capacity could be fueled over the 40-year lifetime of the reactor. Using the material to seed AFR capacity would result in over 26 GWe of capacity for the same 40-year lifetime (the 26 GWe value is especially significant because it is close to the total capacity of nuclear power which is currently produced in Russia).

These economic results become even more striking if we consider the costs involved with storing and protecting plutonium. Because the thermal cycles each burn down material over a long period of time and produce waste that must be stored indefinitely, there is a significant cost involved with the storage of material. If these costs are included in the economic analysis, the AFR seems even more attractive. In each of the baseline cases considered, the thermal cycles result in a net economic loss or small profit, if the storage costs are considered. Only the AFR cycle results in significant net profit from power generation from excess plutonium.

Extensions:

The scenarios selected for analysis and the model results represent simplified cases of what might actually occur in Russia. There are several considerations that are of interest for further study using this model.

Variable Safeguard Capacities – All of the analysis presented in this report is based on cases with fixed levels of material safeguard capacity, in order to simplify the analysis. In Baseline A, it was assumed that there was sufficient capacity to protect 15 tonnes of material at high-safeguard levels and 20 tonnes at moderate safeguard levels. In Baselines B and C, 80 tonnes of high safeguard capacity was available and 105 tonnes of moderate safeguard capacity. It is likely that the actual level of safeguards that are available will be variable and proportional to the volume and status of material. By varying the levels of safeguards, it would be possible to perform trade-offs between the level of material concern and the storage costs. It is probable that a more optimal level of storage could be found.

Weapon Destruction Rate – The Baselines presented in this report also assume that the level of excess material will be constant. While, in fact, as weapons are decommissioned, this level will likely grow. The model has the capability to handle this issue and can look at various levels of weapons destruction. Depending on the destruction rate, there will be definite impacts on the level of concern and the economics of the analysis.

Complex Reactor Cycles – Each of the reactor cycles considered here is distinct and somewhat simplistic. The analysis assumes that only one reactor technology will be used and that all reactors will come on-line at the same time. It may be of interest to look at combined cycles and more realistic build periods. It might be possible to reduce the level of concern and improve earnings by beginning to dispose of some plutonium in the short-term using LWR's or HTGR's and transitioning to AFR's in the long term. The model can handle this type of combined cycle.

Russian Recidivism – The concern analysis presented here is related only to one particular threat, the threat of outside parties illegally obtaining plutonium out of Russian storage. The level of safeguards therefore is an important factor. In the long term, the U.S. might also be concerned with the possibility of Russian recidivism. That is, the possibility that the Russians will attempt to turn excess plutonium back into weapons. In this case the level of safeguards protecting the material is irrelevant.

Fuel Manufacturing to Reduce Threat – Another possibility to reduce concern, which has been discussed, is to convert excess separated plutonium into fuel in advance of reactors being built. The idea is that the fuel facilities could be built more quickly than the reactors themselves. The fuel would be more difficult to convert to weapon form and therefore would pose less of a threat but would still be available for eventual burning. In all of the cases analyzed, only enough fuel manufacturing capacity is constructed to support the reactors. It may be possible by varying this assumption to produce a more optimal concern-cost distribution.

Lifetime Economics - The economic analysis presented in this report concerns only revenues, facility costs and processing costs that occur while the excess plutonium in question is being burned. In actual operation, reactors would continue to operate, using alternate fuels, even after the plutonium was burned. Capital costs, which are calculated over the life of the reactor, will certainly continue to accumulate outside of the plutonium burn period. It would be of interest to look at the lifetime economics of the installed capacity, using costs for alternate fuels.

APPENDIX 1: The *Russian Plutonium Disposal Model*

Introduction

This appendix is intended to describe the structure and operation of the *Russian Plutonium Disposal Model*.

The model contains four separate sectors, each of which investigates an aspect of plutonium disposition in Russia. The four sectors are shown in Figure A.1.

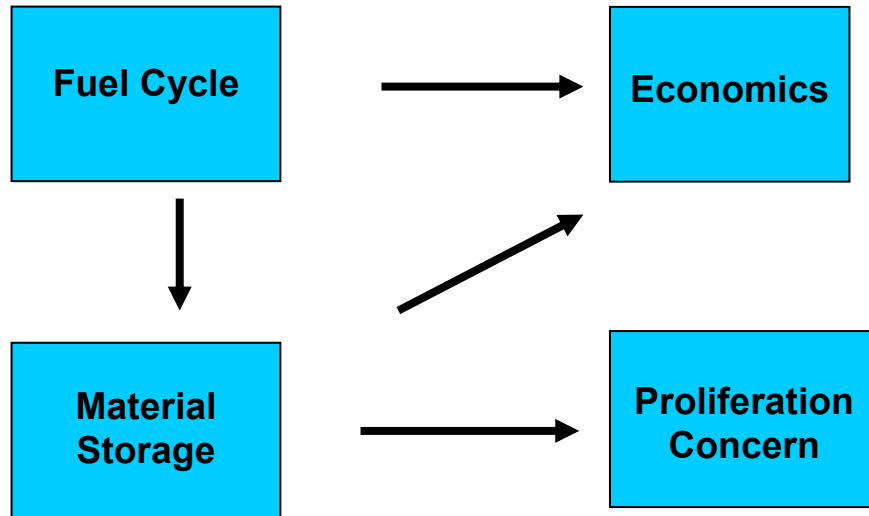

Figure A.1 – Model Sectors

Fuel Cycle:

The primary sector of the model is the Fuel Cycle Sector. This portion examines the flows of excess plutonium through the reactor cycle for each of the three reactor types represented in the model: LWR-MOX, HTGR, and AFR. The basic flow of material is shown in Figure A.2. Material begins in the model as excess separated plutonium. The excess plutonium is directed to each reactor cycle based on the opening times and capacity. In each reactor cycle plutonium is converted into a form suitable for burning, manufactured into fuel, and loaded into the reactor. Based on the particular reactor parameters, a fraction of the plutonium is destroyed in the reactor and the remaining fraction is unloaded in the form of plutonium in waste.

The rates at which each of the operations in the reactor cycle occur are dependant on the performance parameters for a particular type of reactor, the reactor capacity, and the fuel processing capacity specified for each scenario. The model is set-up to use the stock of excess plutonium in whichever reactor cycle is specified. All reactor cycles have equal priority in receiving material. If there is no excess plutonium, the flows in each cycle will stop.

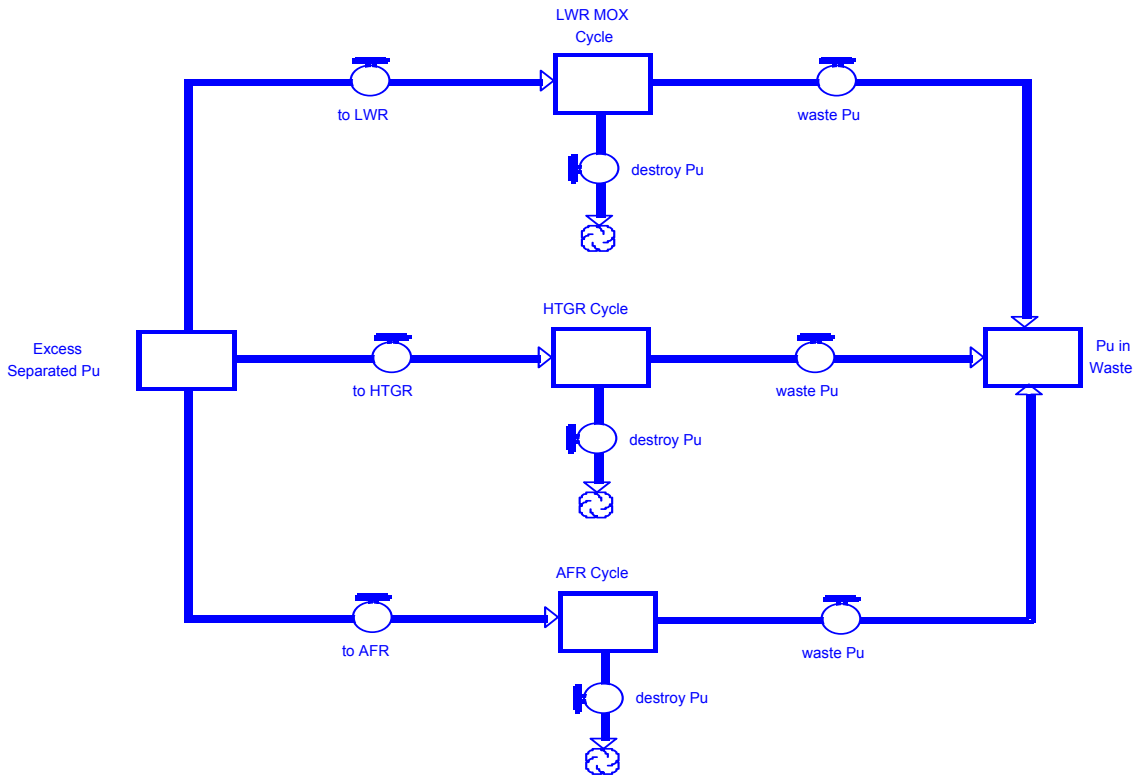

Figure A.2 – Material Flows

The structure depicted above is representative of the overall material flow that takes place in the model. The detailed structure for each of the three reactor cycles is dependant on the reactor type. The actual model structure for the LWR-MOX is shown in Figure A.3.

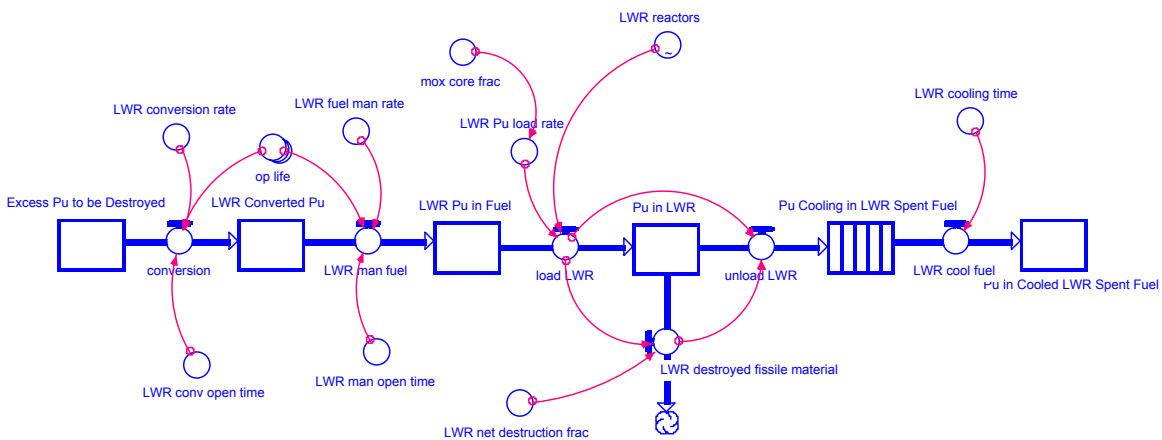

Figure A.3 – LWR-MOX Cycle

In this cycle, a quantity of material begins in the model in the stock “Excess Pu to be Destroyed”. At a time specified by “LWR conv open time”, the material is

converted to the stock, “LWR converted Pu”, at a rate “LWR conversion rate”. Both the conversion open time and the conversion rate are specified as inputs to the model. The conversion process continues as long as material is available in the Excess Pu stock or until the “op life” of the facility, specified as 20 years, is reached. Converted plutonium is then manufactured into fuel in the stock, “LWR Pu in Fuel”. This process begins at “LWR man open time” and occurs at the rate specified in “LWR fuel man rate”. The op life for this facility is also specified as 20 years.

Based on the reactor capacity profile specified in “LWR reactors”, plutonium is then loaded in the reactor in the stock “Pu in LWR”. The rate of plutonium loading is determined from the LWR load rate, which specifies a typical load rate for a LWR reactor of 0.808 tonnes/GWe-yr, and the mox core fraction, which determines what portion of the core is composed of plutonium. In this model the core fraction is specified as one-third.

$$LWR_Pu_Load_Rate = mox_core_frac * LWR_reactors * 0.808 \frac{tonnes}{GWe * year}$$

Plutonium is then either destroyed or unloaded from the reactor. The amount of plutonium destroyed is determined by the factor, “LWR net destruction frac”. In this model the LWR is assumed to have a destruction fraction of 0.64. That is, approximately 64% of the plutonium that is loaded into the reactor is destroyed in the burning process and 36% of the plutonium is unloaded in the form of spent fuel. These fractions represent net material flows and account for additional plutonium that is created in the burning process. The material not destroyed is unloaded from the reactor into the stock Pu cooling in spent fuel. The material cools for a period of 3 years, as specified in “LWR cooling time”. Finally material moves to the stock “Pu in cooled LWR spent fuel”.

$$Material_Destroyed_in_LWR = 0.64 * LWR_Pu_Load_Rate$$

$$LWR_Pu_Unload_Rate = LWR_PU_Load_Rate - Material_Destroyed_in_LWR$$

The plutonium cycle for the HTGR is essentially the same as for the LWR, except some of the performance parameters are different, reflecting the cycle used in this type of reactor. For the HTGR, the entire core consists of plutonium fuel, therefore a core fraction is not specified.

$$HTGR_Pu_Load_Rate = HTGR_reactors * 0.556 \frac{tonnes}{GWe * year}$$

The operating life of both the reactors and the fuel manufacturing facilities are specified as 40 years. The net destruction fraction for the HTGR is set at .90, meaning that 90% of the plutonium is destroyed in the cycle. The HTGR cycle is shown in Figure A.4.

$$Material_Destroyed_in_HTGR = 0.90 * HTGR_Pu_Load_Rate$$

$$HTGR_Pu_Unload_Rate = HTGR_PU_Load_Rate - Material_Destroyed_in_HTGR$$

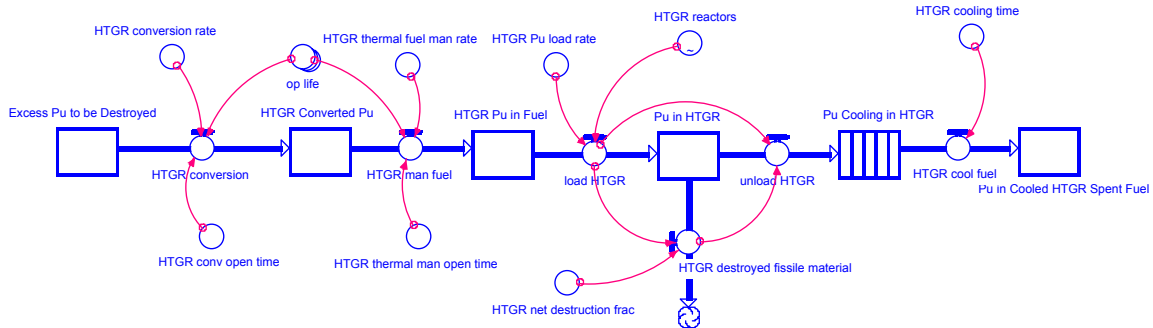

Figure A.4 – HTGR Cycle

The fuel cycle for the AFR is similar to those for the LWR and HTGR, however, there are some critical differences in fuel processing and loading. The AFR fuel cycle is shown in Figure A.5. For the AFR, there is a single fuel manufacturing facility that supports the reactors. No separate conversion plant is included.

The operation of the AFR within this model is considered to be a single step in the fuel cycle. That is, the model does not specifically represent the reprocessing and reloading of plutonium into the reactor. Only the net flows of plutonium into and out of the reactor in the forms of fuel and waste are modeled. The loading of plutonium into the reactor takes place in two forms. First, an initial load of plutonium fuel is needed to seed the reactor. This occurs only when new capacity first comes on line and the amount of plutonium required is proportional to the capacity. In this model an initial load rate of 7 tonnes of Pu per GWe is used.

$$AFR_Initial_Load = AFR_reactors * 7.0 \frac{tonnes}{GWe}$$

In addition, a make-up feed of plutonium may be required, based on the conversion ratio of the reactor selected. For conversion ratios less than 1.0, a make-up feed will be required.

$$AFR_Makeup_Feed = AFR_reactors * (1 - conversion_ratio) * 0.995 \frac{tonnes}{GWe}$$

[if conversion_ratio is less than 1.0]

The net destruction fraction of the AFR is also dependant on the conversion ratio. For ratios at or less than 1.0, no plutonium will be produced by the reactor in the form of waste. For conversion ratios greater than 1.0, there will be a plutonium flow from the reactor.

$$AFR_Unload_rate = AFR_reactors * (conversion_ratio - 1) * 0.995 \frac{tonnes}{GWe}$$

[if conversion_ratio is greater than 1.0]

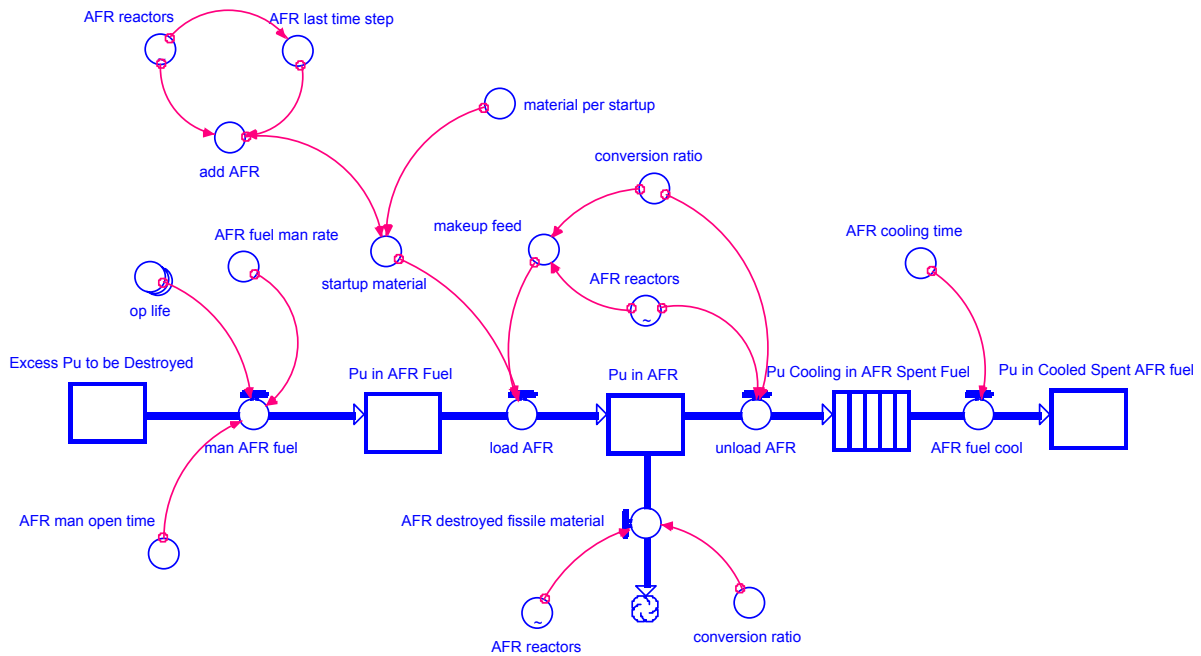

Figure A.5 – AFR Cycle

Since the purpose of this model is to analyze the disposition of the excess plutonium, the model does not simulate the potential continued operation of reactors with alternate fuel. For example, if a reactor profile is specified which burns down the excess plutonium in a period of 20 years, yet the reactors have a 40 year life, the model does not simulate that additional operational life of the reactor.

Material Storage:

The second sector of the model is the Material Storage sector. This portion of the model determines the total quantity of plutonium that is in the model at any time, the form that it is in, and the level of safeguards that can be applied to protect it. This portion of the model is shown in Figure A.6.

The model categorizes the plutonium into five types: separated plutonium, plutonium in AFR fuel, plutonium in thermal fuel, plutonium in AFR waste, and plutonium in thermal waste. Separated plutonium is any material in the initial stock that has not yet been processed. Plutonium in thermal fuel and waste encompasses both LWR-MOX and HTGR cycles. Plutonium in fuel includes all material in the stocks “Converted Pu” and “Pu in Fuel” for each reactor type. Plutonium in waste includes all material in the stocks “Pu Cooling in Spent Fuel” and “Pu in Cooled Spent Fuel” for each reactor type.

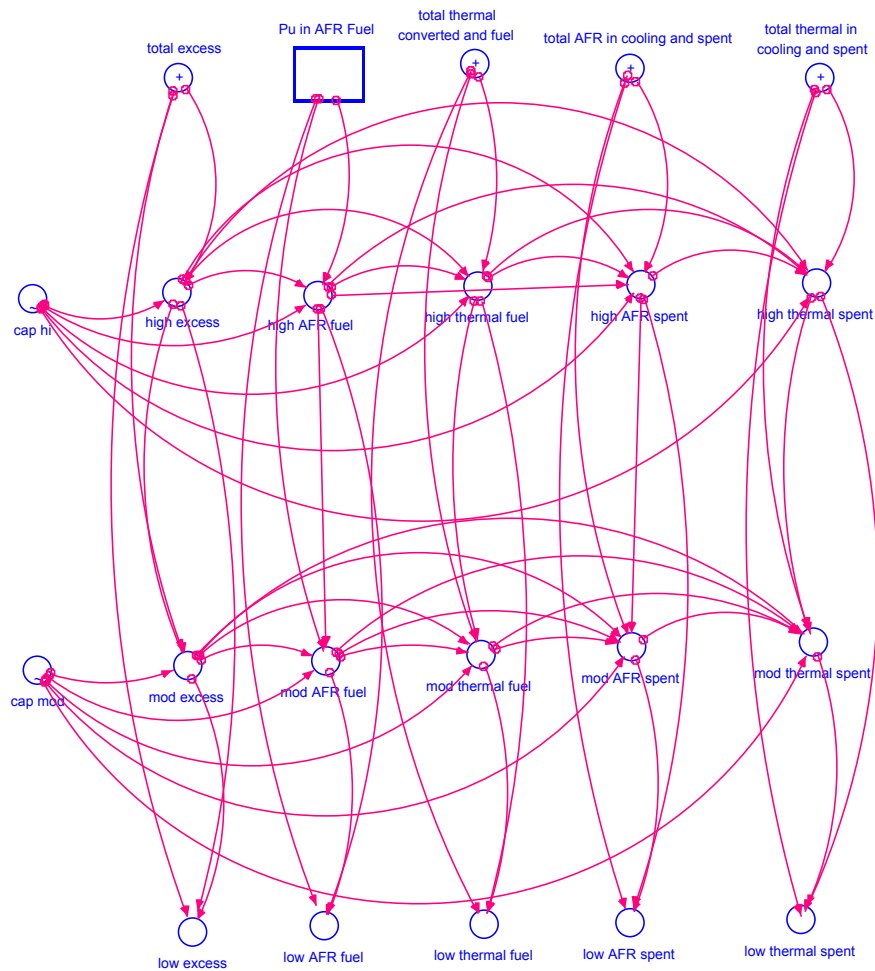

Figure A.6 – Material Protection

This sector of the model determines at what level the plutonium in each form is protected. Material protection is specified at three different levels: high, moderate, and low. High safeguards are considered to be those equivalent to those at a Pantex type storage facility. Moderate safeguard are equivalent to those provided in IAEA type storage. Low safeguards indicate that there is little protection.

In this model, the safeguard capacity is considered to be a limited commodity. As an input variable, users specify the capacity of high and moderate safeguards that Russia will be able to supply over time. The model then takes the available capacity and assigns it to the current distribution of plutonium on a prioritized basis.

First, available high safeguard storage capacity is applied to any separated plutonium, as there is the greatest concern over this material. For this model, “concern” is defined as the effort that would be involved in converting the material

in each form back into a weapon. If there is not enough high safeguard capacity to protect all of the excess material, then any remaining quantity will be protected at moderate and then low safeguards. If there is more than enough high safeguard capacity to protect all of the separated plutonium, then the excess safeguard capacity will be applied to plutonium in fuel and then plutonium in waste. In this manner all of the plutonium in the model will be assigned some level of safeguard. At any point in the simulation, the model calculates the total quantity of each material type at each safeguard level.

Proliferation Concern:

This sector of the model calculates the total level of concern that is presented by the plutonium in the model. The total concern level is calculated based on the quantity of material in each form, the safeguards that are applied, and the threat posed by each type of material.

Initially a weighted threat level is calculated for each material type. The weighted threat is simply a product of the quantity of material and a weighting factor for each level of safeguards. The weighting factor indicates the relative level of protection applied to the material. They are specified on a scale of zero to one, with one being fully protected and zero indicating no protection. Three separate levels of protection are specified in this model. The greatest protection is designated as “high-safeguards”, with a protection level of 0.99. This level of protection is equivalent to those provided at a Pantex type facility. The second level of protection is designated as “moderate-safeguards”, with a protection level of 0.8. The lowest level is designated “low-safeguards” and represents little or no protection, with a weighting factor of 0.0.

For each material type, the amount of material protected at each level is multiplied by one minus the weighting factor and the three values are summed to produce an overall material threat level.

$$Material_Threat = \sum_{protection} Material_Quantity * (1 - protection_weighting_factor)$$

The portion of the model that calculates this quantity for excess separated plutonium is shown in Figure A.7. The same process is repeated for all five material types.

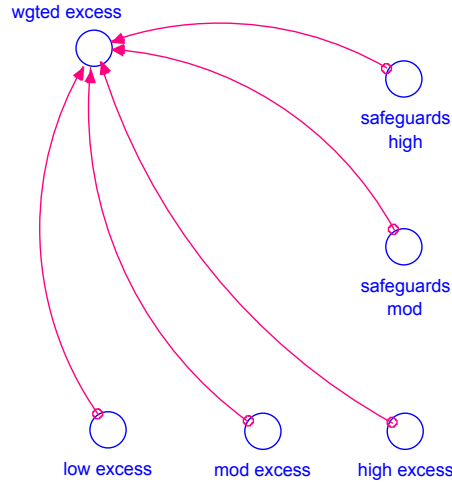

Figure A.7 – Weighted Material Threat

The model then takes the weighted threat level for all of the material types and calculates an overall level of concern. For each material type the weighted material threat is multiplied by a concern index. The concern index is a separate weighting factor based on the relative difficulty of turning material back into a weapon. The concern indexes are specified on a scale of zero to one, with one being the most dangerous and zero the least dangerous. Thus, separated plutonium is given a concern level of 0.5, plutonium in fuel has a concern level of 0.2, and plutonium in waste has a concern level of 0.05. The total weighted plutonium material concern is calculated as the sum of the levels of concern for each material type.

$$Weighted_Material_Concern = \sum_{type} Material_Threat * Concern_Level$$

The portion of the model that calculates this value is shown in Figure A.8. The total represents an equivalent quantity of material that is thought to be “in danger of diversion” at any given time. This final number is then divided in the model by the volume of plutonium required per weapon to produce an equivalent number of weapons. This value is a rough estimate of the total number of weapons that could be possibly constructed from diverted plutonium at any time.

$$Total_Concern = \frac{Weighted_Material_Concern}{0.01\text{tonnes}/\text{weapon}}$$

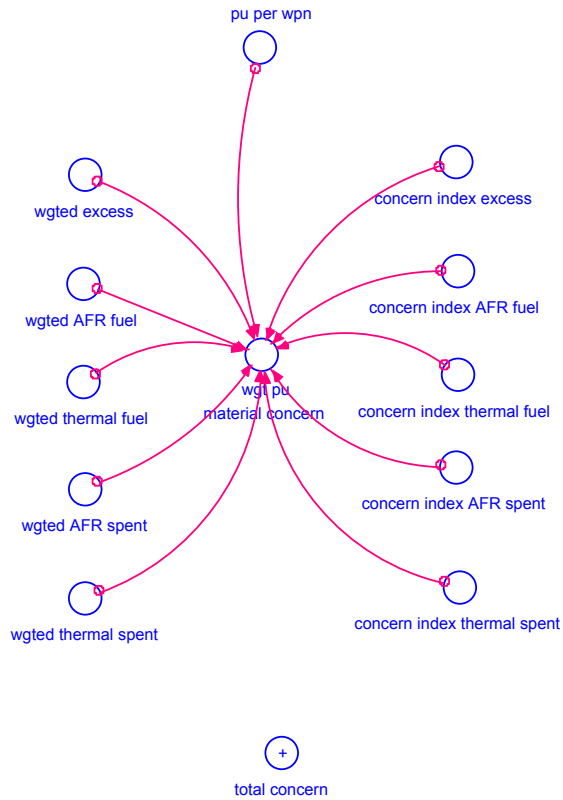

Figure A.8 – Total Material Concern

Economics:

The last sector of the model evaluates the economics involved with the burning of the plutonium. The model looks at both the potential revenues generated through electricity production and the costs of building facilities, processing material, and providing safeguards.

It must be noted that the revenues and costs calculated in the model are for comparative purposes only. The economics of future nuclear power generation are extremely volatile and difficult to predict. The model attempts to compare the economics for each reactor cycle rather than predict actual earnings.

The costs calculated by the model are divided into three parts: capital costs, processing costs, and storage costs. The capital costs represent the annualized cost of building or converting the fuel processing and reactor capacities specified in the material sector. The portion of the model that determines capital costs is shown in Figure A.9.

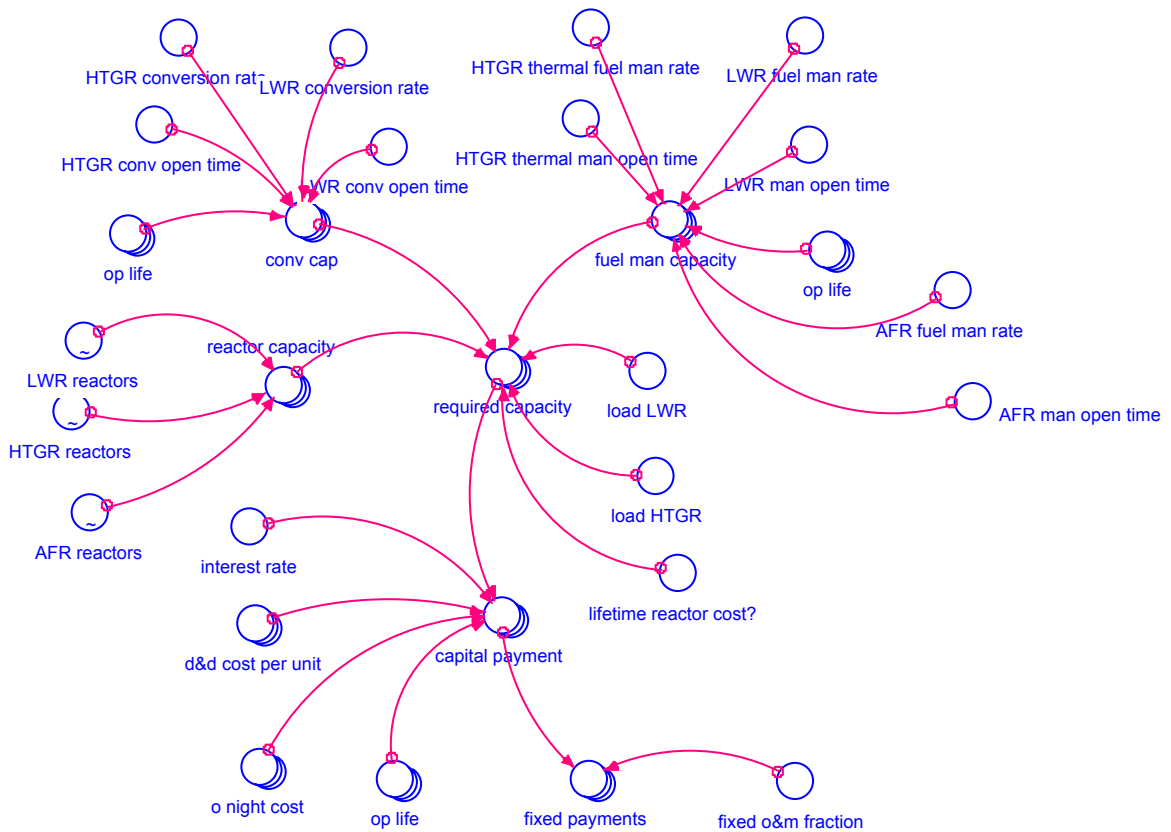

Figure A.9 – Capital Costs

The annual capital cost is a function of the required capacity of each facility type, the overnight cost of building that capacity, the ultimate disposal cost of the facility, and an assumed interest rate. The capital payments are spread over the operating life of each particular facility.

Although the capital payment is calculated for the entire facility life, the model accounts for the annualized capital cost only for the period of time when the facilities are processing excess plutonium. For example, in the case of an HTGR option, the reactor might burn an available amount of excess plutonium in 20 years after opening. The reactor has an operating life of 40 years however. In this case, the total capital cost of the reactor is annualized over the 40-year life, but clearly capital payments would be included in the economic analysis only for the 20 years that the reactor burns plutonium.

At any given time, the model calculates the required capacity for each type of facility. The values are brought together in the array “required capacity”. Each required capacity is then used, along with an operating life, disposal cost, and interest rate, to determine an annualized cost of the facility in “capital payment”.

$$\text{Capital_Payment}(\text{facility}) = \text{PMT}[\text{interest_rate}, \text{operating_life}(\text{facility}), \text{overnight_cost}(\text{facility}), \text{end_of_life_cost}(\text{facility})] * \text{required_capacity}(\text{facility})$$

Finally the individual capital payments are multiplied by a factor, “fixed O&M fraction”, to account for overhead and maintenance costs of the facilities. The final fixed payments for each facility are calculated in the array, “fixed payments”.

$$Fixed_Payment = Capital_Payment * O \& M_Fraction$$

The model next calculates the variable costs associated with processing the plutonium in each of the steps in the reactor cycles. This simple calculation multiplies the instantaneous required capacities for each facility in the array “required capacity”, described above, by a per unit processing cost for each facility. The processing costs are specified by a rate in dollars per tonne of plutonium. The processing costs are determined in the array “variable costs”. This portion of the model is shown in Figure A.10.

$$variable_cost(facility)=required_capacity(facility)*material_unit_cost(facility)$$

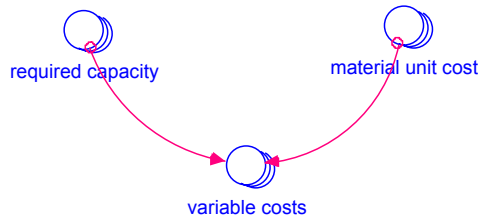

Figure A.10 – Processing Costs

The last costs calculated in the model are the storage costs. This portion of the model is shown in Figure A.11. The model first sums the total amount of material that is protected at each level at any time. These quantities are summed in the converters, “sum hi”, “sum mod”, and “sum lo”. The level of storage at any time is the actual amount of material being protected at that level, not the total capacity available that is specified as an input to the model. Capacity that is not assigned is considered to be unused and the cost is not accounted for. The levels of storage are brought together in the array “storage volume”. The storage volumes are then multiplied by per unit cost for each level of storage, “rate of storage cost” to determine the cost of the storage, “storage cost”.

$$storage_cost=sum_hi*high_storage_cost+ sum_mod*moderate_storage_cost+ sum_lo*low_storage_cost$$

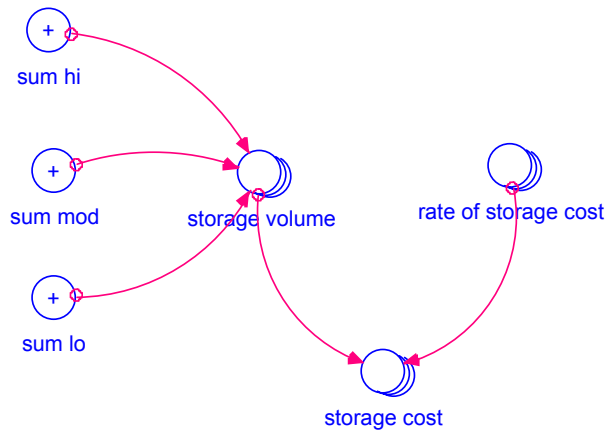

Figure A.11 – Storage Costs

The portion of the model shown in Figure A.12 calculates revenues generated by the model. The revenues for each reactor type are simply the product of the reactor capacity and a power tariff. The power tariff is specified in dollars per kilowatt-hour generated. The revenues for the LWR-MOX are factored by the MOX core fraction for the reactors. If only one-third of the core is MOX, then only one-third of the power produced by the reactor is included in the revenue analysis.

$$Revenue(type) = [capacity(LWR) * mox_core_fraction + capacity(HTGR) + capacity(AFR)] * power_tariff$$

Revenues from the reactors can be calculated either for the lifetime of the reactors or for the period over which they burn excess plutonium. If the switch “lifetime reactor revenue?” is on, revenues will be calculated for the entire reactor life. If the switch is off, revenues will only be calculated while plutonium is being loaded and burned in the reactors.

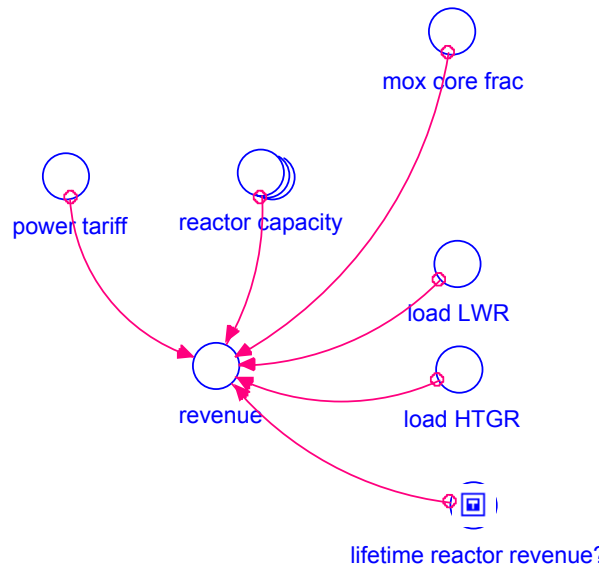

Figure A.12 - Revenues

Finally, the total costs and total revenues are brought together to produce a cash flow for the selected reactor cycle. This step is shown in Figure A.13. Cash flows into the stock “Total Earnings” at the rate specified in “annual revenues”. The cash flows rate is named “annual costs.” It is simply a sum of the capital, variable, and storage costs. The stock total earnings represent the total amount of money made or lost over the life of the simulation.

$$Total_Earnings = \int revenues - fixed_payments - variable_costs - storage_costs$$

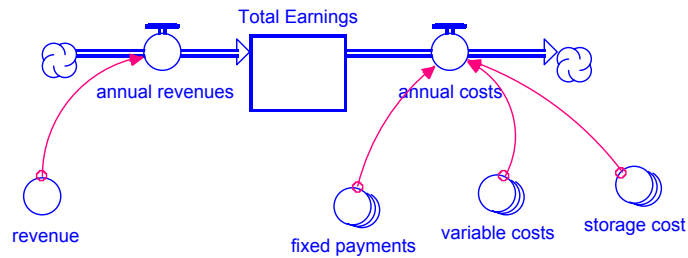

Figure A.13 - Earnings

Table A.1 – Model Variables

FUEL CYCLE			
Input	Description	Value	Unit
<i>Total Weapons</i>	Remaining number of weapons in Russian inventory	10,000	<i>weapons</i>
<i>Rate of wpn destruction</i>	Rate at which weapons are disassembled	0	$\frac{\text{weapons}}{\text{year}}$
<i>Pu per weapon</i>	Average weight of plutonium per weapon	0.01	$\frac{\text{tonnes}}{\text{weapon}}$
<i>Excess Pu to be Destroyed</i>	Initial amount of excess weapons plutonium under consideration	35	<i>tonnes</i>
<i>Additional Pu</i>	Additional excess weapons plutonium to be considered in model	150	<i>tonnes</i>
<i>HTGR Pu load rate</i>	Rate plutonium is loaded into operating HTGR reactors	0.56	$\frac{\text{tonnes}}{\text{GWe} * \text{year}}$
<i>HTGR net destruction frac</i>	Net fraction of loaded plutonium which is destroyed in HTGR reactors	0.90	<i>N / A</i>
<i>HTGR cooling time</i>	Time spent fuel unloaded from HTGR reactor must cool before permanently stored	3	<i>years</i>
<i>Mox core fraction</i>	Fraction of core converted to burn MOX fuel in LWR-MOX reactors	0.33	<i>N / A</i>
<i>LWR net destruction frac</i>	Net fraction of loaded plutonium which is destroyed in LWR-MOX reactors	0.65	<i>N / A</i>
<i>LWR cooling time</i>	Time spent fuel unloaded from LWR reactor must cool before permanently stored	3	<i>years</i>
<i>Material per startup</i>	Plutonium required for initial load-up of AFR reactors	7	$\frac{\text{tonnes}}{\text{GWe}}$
<i>AFR cooling time</i>	Time spent fuel unloaded from AFR reactor must cool before permanently stored	3	<i>years</i>

ECONOMICS			
Input	Description	Value	Unit
<i>o night cost(LWR,conv)</i>	Capital cost of building LWR-MOX conversion facilities	28	$\frac{\$M}{\text{tonne/yr}}$
<i>o night cost(LWR,fab)</i>	Capital cost of building LWR-MOX fuel fabrication facilities	116	$\frac{\$M}{\text{tonne/yr}}$
<i>o night cost(LWR,burn)</i>	Capital cost of converting LWR reactors to burn MOX fuel	245	$\frac{\$M}{GWe}$
<i>o night cost(HTGR,conv)</i>	Capital cost of building HTGR conversion facilities	28	$\frac{\$M}{\text{tonne/yr}}$
<i>o night cost(HTGR,fab)</i>	Capital cost of building HTGR fuel fabrication facilities	116	$\frac{\$M}{\text{tonne/yr}}$
<i>o night cost(HTGR,burn)</i>	Capital cost of building HTGR reactors	1000	$\frac{\$M}{GWe}$
<i>o night cost(AFR,fab)</i>	Capital cost of building AFR fuel fabrication facilities	116	$\frac{\$M}{\text{tonne/yr}}$
<i>o night cost(AFR,burn)</i>	Capital cost of building AFR reactors	1500	$\frac{\$M}{GWe}$
<i>fixed O&M fraction</i>	Operation and maintenance costs for all facilities as a fraction of capital payments	0.05	<i>N / A</i>
<i>d&d cost(LWR,conv)</i>	End-of-life cost for LWR-MOX conversion facilities	75	$\frac{\$M}{\text{tonne/yr}}$
<i>d&d cost(LWR,fab)</i>	End-of-life cost for LWR-MOX fuel fabrication facilities	75	$\frac{\$M}{\text{tonne/yr}}$
<i>d&d cost(LWR,burn)</i>	End-of-life cost for LWR-MOX reactors	100	$\frac{\$M}{GWe}$
<i>d&d cost(HTGR,conv)</i>	End-of-life cost for HTGR conversion facilities	75	$\frac{\$M}{\text{tonne/yr}}$
<i>d&d cost(HTGR,fab)</i>	End-of-life cost for HTGR fuel fabrication facilities	75	$\frac{\$M}{\text{tonne/yr}}$
<i>d&d cost(HTGR,burn)</i>	End-of-life cost for HTGR reactors	100	$\frac{\$M}{GWe}$
<i>d&d cost(AFR,fab)</i>	End-of-life cost for AFR fuel fabrication facilities	75	$\frac{\$M}{\text{tonne/yr}}$
<i>d&d cost(AFR,burn)</i>	End-of-life cost for AFR conversion reactors	100	$\frac{\$M}{GWe}$

ECONOMICS (cont.)			
Input	Description	Value	Unit
<i>rate of storage cost (lo)</i>	Cost of providing low-safeguard storage for plutonium	0.5	$\frac{\$M}{\text{tonne} * \text{year}}$
<i>rate of storage cost (mod)</i>	Cost of providing moderate-safeguard storage for plutonium	2.0	$\frac{\$M}{\text{tonne} * \text{year}}$
<i>rate of storage cost (hi)</i>	Cost of providing high-safeguard storage for plutonium	5.0	$\frac{\$M}{\text{tonne} * \text{year}}$
<i>op life(LWR, conv)</i>	Operating life of LWR-MOX conversion facilities	20	years
<i>op life(LWR, fab)</i>	Operating life of LWR-MOX fuel fabrication facilities	20	years
<i>op life(LWR, burn)</i>	Remaining operating life of LWR-MOX converted reactors	20	years
<i>op life(HTGR, conv)</i>	Operating life of HTGR conversion facilities	40	years
<i>op life(HTGR, fab)</i>	Operating life of HTGR fuel fabrication facilities	40	years
<i>op life(HTGR, burn)</i>	Operating life of HTGR reactors	40	years
<i>op life(AFR, fab)</i>	Operating life of AFR fuel fabrication facilities	40	years
<i>op life(AFR, burn)</i>	Operating life of AFR reactors	40	years
<i>power tariff</i>	Value of electricity generated	192.75	$\frac{\$M}{GWe * \text{year}}$
<i>material unit cost(LWR,conv)</i>	Cost of converting plutonium for LWR-MOX fuel	4.5	$\frac{\$M}{\text{tonne}}$
<i>material unit cost(LWR,fab)</i>	Cost of fabricating fuel for LWR-MOX	19.5	$\frac{\$M}{\text{tonne}}$
<i>material unit cost(LWR,burn)</i>	Cost of burning plutonium fuel in LWR-MOX	12.0	$\frac{\$M}{GWe * \text{year}}$
<i>material unit cost(HTGR,conv)</i>	Cost of converting plutonium for HTGR fuel	4.5	$\frac{\$M}{\text{tonne}}$
<i>material unit cost(HTGR,fab)</i>	Cost of fabricating fuel for HTGR	28.4	$\frac{\$M}{\text{tonne}}$
<i>material unit cost(HTGR,burn)</i>	Cost of burning plutonium fuel in HTGR	25.6	$\frac{\$M}{GWe * \text{year}}$
<i>material unit cost(AFR,fab)</i>	Cost of fabricating fuel for AFR	35	$\frac{\$M}{\text{tonne}}$
<i>material unit cost(AFR,burn)</i>	Cost of burning plutonium fuel in AFR	36	$\frac{\$M}{GWe * \text{year}}$

PROLIFERATION CONCERN			
Input	Description	Value	Unit
<i>safeguards high</i>	Protection weighting factor for material protected at a high-level of safeguards	0.99	<i>N / A</i>
<i>safeguards moderate</i>	Protection weighting factor for material protected at a moderate-level of safeguards	0.8	<i>N / A</i>
<i>concern index excess</i>	Material weighting factor for excess separated plutonium	0.5	<i>N / A</i>
<i>concern index fuel</i>	Material weighting factor for converted plutonium and plutonium in fuel	0.2	<i>N / A</i>
<i>concern index spent</i>	Material weighting factor for plutonium in reactor and plutonium in spent fuel	0.05	<i>N / A</i>

APPENDIX 2: DTRA/NSP Workshop Attendee List, April 18, 2001

First Name	Last Name	Affiliation
Bill	Harris	Amarillo National Research Center
Abdellatif	Yacout	Argonne National Laboratory
Bill	Andrews	Battelle
Jeff	Hughes	DOE
Dan	Nikodem	DOE
Lt. Col. Charles	Allison	DTRA
Tony	Fainberg	DTRA
Starnes	Walker	DTRA
Mark E.	West	DTRA
Maj. Jon	Wozniak	DTRA
Chris	Ellis	General Atomics
Chris	Hamilton	General Atomics
Mark	Haynes	General Atomics
Ted	Quinn	General Atomics
Arkal	Shenoy	General Atomics
Laurin	Dodd	INEEL
Michael S.	Modro	INEEL
Jeff	Stewart	Livermore National Laboratory
Nancy	Suski	Livermore National Laboratory
Randall	Erickson	Los Alamos National Laboratory
Sigfried	Hecker	Los Alamos National Laboratory
Ray	Juzaitis	Los Alamos National Laboratory
Rich	Wagner	Los Alamos National Laboratory
Michael	O'Connell	NNSA
Laura	Holgate	Nuclear Threat Initiative
Cyrus	Afshar	SAIC
Matthew	Crozat	SAIC
Tim	Haley	SAIC
Teresa	Downey	SAIC
Victor	Reis	SAIC
Chel	Stromgren	SAIC
Tom	Sanders	Sandia National Laboratory
Dan	Fenstermacher	U.S. State Department

APPENDIX 3: CSIS Workshop Attendee List, February 14, 2001

First Name	Last Name	Affiliation
William	Harris	Amarillo Center
David	Hill	Argonne National Laboratory
Peter	Planchon	Argonne National Laboratory
Robert	Monroe	Bechtel
William	Bishop	B-Plus, Inc.
J. Malvyn	McKibben	CNTA
Arvid	Jensen	Cogema, Inc.
Alvin	Trivelpiece	Consultant
Bob	Ebel	CSIS
Lisa	Hyland	CSIS
Tony	Fainberg	DTRA
Ray	Durante	Durante Associates
Mark	Haynes	General Atomics
David	Albright	Institute for Science and Intl. Security
Robert	Schock	Lawrence Livermore National Laboratory
Nancy	Suski	Lawrence Livermore National Laboratory
Edward	Arthur	Los Alamos National Laboratory
Deborah	Bennett	Los Alamos National Laboratory
John	Ireland	Los Alamos National Laboratory
Richard	Wagner	Los Alamos National Laboratory
Gordon	Michaels	Oak Ridge National Laboratory
Jonathan	Epstein	Office of Senator Jeff Bingaman
Kristine	Svinicki	Office of Senator Larry E. Craig
Peter	Lyons	Office of Senator Pete Domenici
William	Hoehn	RANSAC
Matthew	Crozat	SAIC
Teresa	Downey	SAIC
R. Evan	Ellis	SAIC
Victor	Reis	SAIC
Margaret	Chu	Sandia National Laboratories
Robert	Eagan	Sandia National Laboratories
Doris	Ellis	Sandia National Laboratories
Stan	Fraley	Sandia National Laboratories
Jeffrey	Hughes	Sandia National Laboratories
Nancy	Prindle	Sandia National Laboratories
Thomas	Sanders	Sandia National Laboratories
Paul	Dickman	U.S. Department of Energy
Richard	Sena	U.S. Department of Energy
John	Stamos	U.S. Department of Energy
Lewis	Steinoff	U.S. Department of Energy
Mel	Buckner	Westinghouse Savannah River Company