

Military Intelligence

PROFESSIONAL BULLETIN

July-September 1998

PB 34-98-3



ENLISTED

WARRANT

OFFICER

INTELLIGENCE TRAINING XXI
READY NOW

FROM THE EDITOR

The last few months at Fort Huachuca, Arizona, have been very exhilarating as the winds of change and celebration swept through. In early June, there was a change of position ceremony for the retiring U.S. Army Intelligence Center and Fort Huachuca Command Sergeant Major, CSM Randolph Hollingsworth, and his replacement, CSM Scott C. Chunn. On 18 June, MG Charles W. Thomas relinquished command of USAIC&FH and the MI Corps to MG John D. Thomas, Jr. The 36th Army Band enlivened the ceremonies with their music and Fort Huachuca's historic B Troop performed their traditional charge across Brown Parade Field. We wish all four individuals the best in their new challenges. The comments from the new USAIC&FH Commander and Command Sergeant Major begin on page 2.

The festivities of 26 June began with the 309th MI Battalion's change of command when LTC Timothy Quinn passed the battalion colors to LTC David Kneafsey. The 313th MI Battalion, 82d Airborne Division, from Fort Bragg, North Carolina, dazzled us with a parachute drop of four waves of soldiers. Later in the morning, the MI Corps inducted three new members into the MI Hall of Fame: LTG Paul Menoher, Jr. (Ret.), CSM Raymond McKnight (Ret.), and COL Seth Nottingham, Jr. (deceased). The 36th annual MI Ball was held that evening at the Lakeside Activities Center.

The 326th MI Battalion reflagged as the 304th. The 326th Commander, LTC Konrad Trautman, continues as the "new" 304th Commander. The functions of the former 304th have migrated to other battalions. (The deactivation of one battalion was a planned part of the USAIC&FH restructure.) Also, the 304th begins its first iteration of the G2/Analysis and Control Element (ACE) Chief Course this August. During the final week of the course, the Battalion presents a week-long simulation exercise timed to coincide with the Capstone Officer Advanced Course (OAC) exercise. In a very clever approach, the exercise—in a notional scenario—employs one corps and two divisional ACEs in which the G2, ACE Chief, and OAC students "work" the positions for which they are training. Excellent hands-on, focused training in the making!

The topic of this issue, "Intelligence Training XXI: Ready Now," heralds exciting changes in our training strategies. Our authors explain the evaluation process, nicknamed "cradle-to-grave," that looks at the career-long training requirements of MI soldiers—in residence, at the units, as individual self-development, and through distance learning. The features also discuss changed training strategies for several enlisted MOSs, a major shift in the focus of the BNCOG and ANCOG training from facts to application, and both new and revised officer training. As you read through this issue of the *MIPB*, you may have additional points of interest for consideration on a given topic—don't keep those good ideas to yourself. Relay your input to the authors. It may all begin with an idea, but ideas have to be enacted to bring them to fruition. Enjoy the following articles and have a great day!

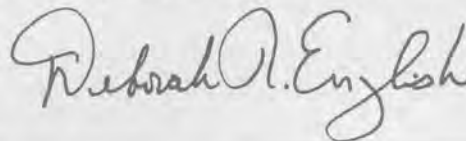

Writer of the Quarter

Sergeant First Class Michael C. Taylor is our Writer of the Quarter, July-September 1998, for the article "The 98C Career Training Strategy." Congratulations to SFC Taylor and all of the other winners and many thanks to all of our authors for their great articles, book reviews, and letters to the editor. Contributions like yours make *MIPB* the professional development forum for military intelligence professionals.

How to Submit an Article

1. Select a relevant topic of interest to the military intelligence community. Plan to write 2000-3000 words, or roughly 3-5 pages.
2. Put the bottom line up front and write clear, concise introduction and conclusion paragraphs. Follow proper rules of grammar. Consult **DA Pamphlet 600-67, Effective Writing for Army Leaders**, or William A. McIntosh's **Guide to Effective Writing**.
3. Maintain the active voice as much as possible. Write "Congress cut the budget" rather than "the budget was cut by Congress."
4. Send the article in Microsoft Word or Word Perfect via E-mail to mipb@huachuca-emh1.army.mil or mail it to Commander, USAIC&FH, ATTN: ATZS-CLM (MIPB), Fort Huachuca, AZ 85613-6000. (Please do not use special document templates.) Include with your article—
 - Pictures, graphics, and crests with adequate descriptions and photographer credits. (We can return photos if so requested.)
 - A release by your local security office stating that your article is unclassified, nonsensitive, and releasable to the public.
 - A short biography with the full names of all authors of the article. The biography should include each author's current duty position, other assignments, civilian degrees, and advanced military education (CGSC, War College, SAMS, MSSJ, SEIP, PGIP, etc.). (Tell us if we can print your telephone number and E-mail address with the biography.)
 - A cover letter with SSN, work, home, and E-mail addresses, and telephone numbers, stating your wish to have the article published.
5. Remember, content is the most important part of your article. When in doubt, **send us your article**—we can work out the details!

Military Intelligence

PB 34-98-3
Volume 24 Number 3
July-September 1998



Check us out on the Internet!
http://138.27.35.36/MIPB/mipb_home/welcome.htm

FEATURES

- 4 Development of the Cradle-to-Grave Training Strategies: Philosophy and Process
by Colonel George K. Gramer, Jr.
Foreword by Brigadier General John W. Smith
- 9 The 98C Career Training Strategy
by Sergeant First Class Michael C. Taylor
- 15 33W Training Strategy
by Sergeant Major Frank Liebsch
- 20 Signals Collection/Identification Analyst (98K) Training
by Chief Warrant Officer Three Katherine I. O'Neal and Warrant Officer One Keith J. Merryman
- 23 Cradle-to-Grave Interrogator Training Using an Embedded AI Device
by Major Jeffrey T. Girard
- 28 MI Officer Training at the Turn of the Century
by Lieutenant Colonel Konrad Trautman
- 34 Sharpening the Edges: Technical Training in the ANCOG
by First Sergeant Bradford R. Jenkins
- 36 The New 98C BNCOC Training Strategy
by First Sergeant Timothy P. Carroll, Jr.
- 39 96B Training Strategy
by Lieutenant Colonel Timothy J. Quinn
- 45 USAIC&FH Foreign Language Initiatives
by Lieutenant Colonel Peter A. Shaver (USA, Retired)
- 47 The National Cryptologic School Adjunct Faculty Program
by Larry N. Hampton
- 49 Distance Learning: Intelligence Training for the 21st Century
by Lieutenant Colonel George A. Wheat
- 54 Military Intelligence Corps Association
by Colonel John H. Black (USA, Retired)
- 62 Glossary [Acronyms for graphics in feature articles]

DEPARTMENTS

- | | |
|------------------------|------------------------|
| 2 Vantage Point | 57 Hall of Fame |
| 3 CSM Forum | 59 Sly Fox |
| 53 Letters | 60 TSM Notes |
| 56 Concepts & Doctrine | 61 Professional Reader |
| 57 Proponent Notes | 65 Unit Profile |

STAFF:

Commanding General
Major General John D. Thomas, Jr.

Director of Continuous Learning
Colonel Steven J. Boltz

Editor
Chief Warrant Officer Three
Deborah A. English

Associate Editor
Elizabeth A. McGovern

Contributing Editors
Second Lieutenant Matthew J. Gallant
Second Lieutenant Jeffrey T. Gibbons

Art Director
Private First Class
Karen E. O'Sullivan-Howell

Graphics Specialists
Specialist Janell J. Emerson
Marvin H. Marcroft

Administration
Cruz M. Martinez

Purpose: The U.S. Army Intelligence Center and Fort Huachuca (USAIC&FH) publishes the *Military Intelligence Professional Bulletin* quarterly under provisions of AR 25-30. *MIPB* disseminates material designed to enhance individuals' knowledge of past, current, and emerging concepts, doctrine, material, training, and professional developments in the MI Corps.

Submissions: Please send your manuscripts, letters to the editor, photographs, and any inquiries to: Commander, USAIC&FH, ATTN: ATZS-CLM, Fort Huachuca, AZ 85613-6000; send via E-mail to mipb@huachuca-emh1.army.mil and an information copy to mcgovern@huachuca-emh1.army.mil; or telephone (520) 538-1004/5 or DSN 879-1004/5.

Subscriptions: Subscription rates are \$7.50 per year (Domestic, APO, and FPO) and \$9.40 per year (Foreign). Send changes of address and subscriptions (see page 14) to Commander, USAIC&FH, ATZS-CLM, Fort Huachuca, AZ 85613-6000. **Keep us informed of your changes of address!** For further information, phone (520) 538-1015 or DSN 879-1015 or E-mail martinezcc@huachuca-emh1.army.mil.

Disclaimer: This publication presents professional information, but the views expressed herein are those of the authors, not the Department of Defense or its elements. The content does not necessarily reflect the official U.S. Army position and does not change or supersede any information in other U.S. Army publications. Use of news items constitutes neither affirmation of their accuracy nor product endorsement. We reserve the right to edit any submitted material.

By Order of the Secretary of the Army:
Official

JOEL B. HUDSON
Acting Administrative Assistant
to the Secretary of the Army

DENNIS J. REIMER
General, United States Army
Chief of Staff

VANTAGE POINT

by Major General John D. Thomas, Jr.

It is an exciting time to be a member of the Military Intelligence Corps. These were my thoughts when I found out that I would be returning to the Intelligence Center. I am sure you all feel the same. It is a real privilege to serve with the outstanding soldiers and civilians of the MI Corps, but at the same time, we confront some significant challenges—stimulating challenges that we all must work as a team to solve.

Three major forces have come together to shape today's environment: the world situation, the continued development of our Army, and the realities of our available resources. We face no world-class peer-competitor on the immediate horizon, but the challenges of regional hegemonists and the unpredictability of regional instability, together with the technological revolution of the information age, form the environment in which we operate. At the same time, the Army is restructuring itself to maintain the overwhelming dominance and agility that guarantees peace while accomplishing today's varied missions. Moreover, we encounter all of this in a period of declining resources. This environment demands that our MI Corps continually reevaluates and postures itself to provide commanders the intelligence they need on which to base their operations.

This process is well along and, under the superb leadership of Major General Chuck Thomas and Brigadier General John Smith, has continued to demonstrate the absolutely critical role of intelligence in the Army of the 21st Century. Nevertheless, the process is not over and we need to continue the work underway. This is not a task for only the Intelligence Center; it is a task for all of us. There is tremendous experience and vision throughout the MI Corps. The innovation of III Corps during the Advanced Warfighting Experiments and the outstanding professionalism of our soldiers and leaders in Bosnia, Southwest Asia, and Korea as they confront today's missions are but two examples of how we are meeting the challenge of today's and tomorrow's environment. The day-to-day first-class intelligence work of the U.S. Army Intelligence and Security Command units worldwide is another example.

The key to success in this effort is teamwork. We must work through this together and focus on what is right for tomorrow's MI Corps. We must integrate our Active and Reserve Components and capitalize on the MI "system of systems," realizing



U.S. Army photo

that all capabilities for every contingency will not be available in a single unit or echelon. We need to understand how to ensure that the entire intelligence system, from national agencies to organic resources, supports our commanders.

We must focus on several major issues in the near term. First, active participation in the Army Experimental Campaign Plan that is the continued development of Force XXI in the divisions, at the echelons above division, and at the Strike Force. This will prepare our organizational structure to provide the best support for tomorrow's Army. Additionally, there are several issues affecting the entire MI Corps that we must address. They are:

- Technical competency at all levels.
- Collective intelligence training for MI units and supported commanders.
- Our enlisted structure.
- Increased counterintelligence/human intelligence (CI/HUMINT) capability.

- Integration of measurement and signature intelligence (MASINT) to support the tactical commander.
- Signals intelligence (SIGINT) in the information age.
- Intelligence support to information operations.

I intend to focus on these issues as Chief of MI, but I cannot do it alone; I need the input and support of you all. There are tough decisions to make and they require the efforts of everyone. I want and need your input. Please stay in touch with the issues and share your thoughts and ideas.

Although there are many challenges ahead, I remain confident that the solutions will come from our people. We just completed our annual Hall of Fame Induction Ceremony and that is a great opportunity to reflect on the tremendous talent within our Corps. We recognized Command Sergeant Major Ray McKnight, Colonel Seth Nottingham, and Lieutenant General Paul Menoher; there are many more McKnights, Nottinghams, and Menohers in our Corps. Our mission is to encourage and support them---they are our future.

ALWAYS OUT FRONT!

CSM FORUM

by **Command Sergeant Major Scott C. Chunn**

The theme for this issue of the *Military Intelligence Professional Bulletin* is "Intelligence Training XXI: Ready Now." I have been away from the Intelligence Center and Fort Huachuca for almost 15 years and it is exciting to see the changes and accomplishments made while I have been away. I am thrilled to be the MI Corps' CSM and look forward to visiting the field units, sharing with you what we are doing here at your school and Intelligence Center, and bringing back information on what is working in the field and what is not. In this world of automation, communications should be easier than ever before; I encourage you reach out and let us know what you are doing and help us to incorporate your good ideas with what we are doing here. One of the best ways to do this is by contributing articles to the *MIPB*. Seeking results through innovation, striving for improvement, staying on top of change, and conducting realistic training will be very challenging for the MI leader---tell us how you are accomplishing that and share your successes.

The action plan for **Intelligence Training XXI: Ready Now** was published in 1997. If you have not read it, I would encourage each of you to do so. It establishes the Army's concept for training military intelligence soldiers, leaders, and forces Army-wide to perform effectively on the Army XXI battlefield. It lays out an azimuth for our training future and provides a road map for us to get there.

To meet the many implications and requirements for training the 21st Century force, the Intelligence Center has established training imperatives that drive all training and training development. These training imperatives are as follows:



U.S. Army photo

- Seamless Training Architecture.** The Intelligence Center must develop and provide a connection between individual and collective training, and between the training conducted at the Intelligence Center and by units in the field.

(Continued on page 14)

Development of the Cradle-to-Grave Training Strategies: Philosophy and Process



U.S. Army photo

Intelligence Training XXI

Introductory comments by Brigadier General John W. Smith

Training is alive and well—and getting healthier and stronger every day at Fort Huachuca, Arizona. In 1997, we realized that the pathway to the future of training in the U.S. Army Intelligence Center (USAIC) needed to change from the past approach. The result was a thorough analysis of the way we do business, and the publication of the **Intelligence Training XXI: Ready Now—1997 Action Plan**. USAIC wrote the plan based on the following four goals:

- Construct training and a training environment that will produce joint information age warriors—the intelligence leaders of the 21st Century.
- Develop an MI “schoolhouse without walls” to facilitate seamless training between the Intelligence Center and the field units.
- Develop, field, and sustain flexible, realistic, and robust intelligence training materials, simulations, and devices.
- Improve the intelligence training provided to combined arms soldiers, staffs, and commanders.

This issue of *Military Intelligence Professional Bulletin* focuses on what we are doing that is new in training at the Intelligence Center. Several of the articles concentrate on the first goal and what we have been doing to improve and update the intelligence training strategies and chart MI soldiers’ continuous professional development throughout their careers. We improved the strategies—for both the Active Component and the Reserve Component soldiers—to enhance professional development from service entry to retirement.

During the last twelve months, the 111th MI Brigade, the Directorate of Continuous Learning, and other elements of the Center have examined the ways we currently train several of our MI military occupational specialties (MOSs). These analyses, nicknamed “cradle-to-grave” training strategies, are the initial attempt to articulate what is needed to ensure that the soldiers of the 21st Century are trained and ready to execute the intelligence missions ahead.

I believe that you will find the training battalions, the Noncommissioned Officer Academy, and others at the Center have developed some superb training strategies. They set the direction we need to go for officer training and MOS 33W (Electronic Warfare/Intelligence Systems Repairer), 96B (Intelligence Analyst), 98C (Signals Intelligence (SIGINT) Analyst), and 98K (Signals Collection/Identification Analyst). In addition, this issue of *Military Intelligence Professional Bulletin* presents two exceptional programs in the language training and distance learning arena: Foreign Language Instruction via Distance Learning and the Language MOS Evaluation Program.

The outstanding efforts, particularly of the noncommissioned officers (NCOs) in the Intelligence Center, to bring innovation and vitality to the USAIC training arenas will reap long-term benefits within the MI Corps. This is true whether at Fort Huachuca, Goodfellow Air Force Base (AFB), Texas, or Corry Naval Air Station (NAS) in Pensacola, Florida. The cradle-to-grave training strategies, language initiatives, All-Source Analysis System (ASAS) Master Analyst Course (AMAC), and new efforts in modeling and simulations are all the results of our dedicated Intelligence Center workforce—a team dedicated to the goal that the MI Corps will always be out front.

The following article by Colonel George Gramer outlines the philosophical and procedural underpinnings of our new training strategy methodology. The training strategy development was also a seminar item at the G2/MI Commanders’ Conference conducted at Fort Huachuca in September 1998.

Always Out Front!

by Colonel
George K. Gramer, Jr.

Change affects the way we do things in Army intelligence. The sets of skills required by the MI private of 1968 were far different from the skills needed by that same private retiring in 1998 as a sergeant major. In that same vein, the privates being trained today in initial entry training (IET) will face many changes in the courses of their careers as they move through Force XXI, to the Army After Next, and what lies beyond. The U.S. Army Intelligence Center must foresee change and have ready a coherent training strategy for our MI soldiers to ensure constant currency. We must provide them with up-to-date doctrine; tactics, techniques, and procedures (TTP); equipment; and all of the other factors influencing them throughout the entirety of their careers.

Until now, training strategy development stitched together a patchwork quilt of training, often without coherent rhyme or reason. This article discusses the philosophy behind and the procedures for the new methodology used to develop our cradle-to-grave training strategies. This methodology will ensure a framework wherein the USAIC weaves a tapestry of interconnected and interrelated training throughout a soldier's career.

Development of Intelligence Training XXI

Objective 1.1: Revise, update, and improve individual intelligence training strategies for both the Active Component (AC) and Reserve Component (RC) to enable continuous professional development from service entry to retirement.

—Intelligence Training XXI:
Ready Now¹

Our cradle-to-grave training strategies take a multidirectional view that includes every MI area of concentration, specialty, and MOS—in both the AC and RC—for all enlisted and officer training. Each strategy must cover a full plan for a 30-year career of resident and nonresident training. It requires cooperative participation by almost every element of USAIC throughout the entire process, as well as involvement from units in the field and national agencies. (Figure 1 shows a cradle-to-grave training plan for an NCO's career.)

We also integrate several important philosophical points in the development of each of the new training strategies. These points include:

- All training at USAIC represents adult education. The major premise of adult education is that students attend school to learn so the training should be challenging; students should come away with considerably more knowledge than they had on arrival.

- USAIC training should not be redundant; we will not re-teach the skills and knowledge learned in lower skill levels at higher level courses.
- NCOs are more than just managers—we must ensure that our MI NCOs receive the most current and best possible technical training in their NCO Education System (NCOES) courses.
- Training on MI systems is vital. That training must include ample experience on our major systems, particularly the ASAS.
- Training comes in many forms; we must use nonresident and distance learning methods wherever possible.

We must expect NCOs to have certain competencies before they arrive for NCOES schooling. USAIC will establish academic prerequisites for attendance at the Basic Noncommissioned Officer Course (BNCOC) and the Advanced Noncommissioned Officer Course (ANCOC).

Not all "residential" training will be conducted at Fort Huachuca, Goodfellow AFB, or Corry NAS. We expect to begin split-based NCOES and officer courses in the near future, leveraging the power and resources of other training institutions and the national intelligence agencies.

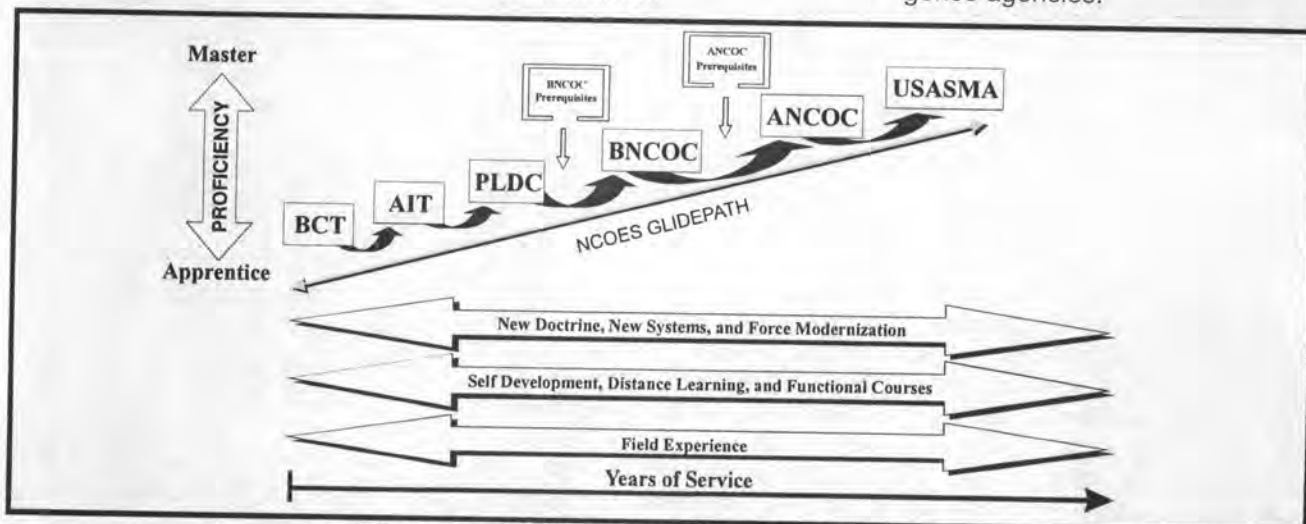

Figure 1. Cradle-to-Grave Training Strategy.

Responsibilities for Training Strategies

From a procedural standpoint, almost every element of USAIC plays a role in the development of the cradle-to-grave training strategies. The 111th MI Brigade and its three battalions are responsible for the orchestration, creation, and update of the training strategies for most enlisted MOSs and skills (see Figure 2). Both the 305th MI Battalion at Fort Huachuca and the 344th MI Battalion at Goodfellow AFB teach portions of the 98C (SIGINT Analyst) course. The 344th teaches the technical skills (Phase I) in approximately 13 weeks; then the 305th teaches the 6-week tactical skills (Phase II) portion (changing to 5 weeks).

The Futures Directorate articulates the force requirements and the vision for each MOS and skill. Their participation involves requirements, doctrine, new systems, MI personnel, training developments, and technical support from the Battle Command Battle Lab-Huachuca (BCBL-H). The Office of the Chief of Military Intelligence (OCMI) identifies the assignment patterns and career models for personnel in each MI MOS and skill level throughout a 30-year career. Into their analysis, OCMI incorporates factors derived from **Army Regulation (AR) 611-201, Enlisted Career Management Fields and Military Occupational Specialties**, other regulatory guidance, Army policy, and ongoing Army initiatives. The Doctrine Division ensures that the training strategies incorporate current and emerging doctrine and TTP. The New Systems Training Office (NSTO) ensures incorporation of the provisions for all new training devices and simulations in the training strategies.

The Directorate of Continuous Learning develops those portions of the training strategies involving 20-, 30-, and 40-level training, self-development training, language training, and incorporation of ASAS training and distance learn-

Element	Responsibilities
111th MI Brigade	Orchestration, creation and update of training strategies for most enlisted MOSs and skills.
305th MI Battalion	33W (Electronic Warfare/Intelligence Equipment Repairer) 96U (UAV Operator) 98C (SIGINT Analyst) Phase II 98H (Communications Locator/Interceptor) 98J (Electronic Intelligence Inceptor/Analyst) 98K (Signals Collection/Identification Analyst)
309th MI Battalion	96B (Intelligence Analyst) 96D (Imagery Analyst) 96H (Imagery Ground Station Operator) 96R (Ground Surveillance Systems Operator) 97B (Counterintelligence Agent) 97E (Interrogator)
344th MI Battalion	98C (SIGINT Analyst) Phase I 98G (Voice Interceptor)
Continuous Learning	20- through 40-level training, self-development training, language training, and incorporation of ASAS training and distance learning methodologies in many courses.
304th MI Battalion	Commissioned and warrant officer training strategies and participates in functional course strategies.
NCOA	NCOES and technical training for BNCOC and ANCOC.
Advanced Individual Skills	MOS 97L Translator/Interpreter (a Reserve-only MOS).

Figure 2. Responsible Elements for MOS-Related Training.

ing methodologies. The responsibilities of the 304th MI Battalion (formerly known as the 326th MI Battalion) and the Noncommissioned Officer Academy (NCOA) appear in Figure 2. The 304th develops officer and warrant officer training strategies and participates in strategy development for functional courses pertaining to each MOS. The NCOA develops the NCOES schooling portions of each training strategy involving the BNCOC and ANCOC. The Advanced Individual Skills (AIS) Division develops the training strategy for the RC-only MOS, 97L (Translator/Interpreter), provides input on all language training issues, and is responsible for developing soldier manuals that reflect the new training strategies. The ASAS Master Analyst Branch of AIS supports development of all training strategies that involve ASAS training, including the AMAC. The Advanced Collective Skills (ACS) Division and the Distance Learning Office are responsible for the acquisition or production of all distance learning materials required to support 20-level training and other self-development training such as that occurring between the BNCOC and ANCOC.

There are many other participants in the training strategy-development process, including:

- U.S. Army Training and Doctrine Command (TRADOC) Systems Managers (TSMs) who provide input and data for those systems under development that affect the way we will train soldiers in the future.
- Office of the Registrar provides structure and guidance on the evaluation of training at all echelons, student attrition statistics and throughput data, and subject matter experts (SMEs), as required.
- Reserve Component Advisors for the U.S. Army Reserve (USAR) and U.S. Army National Guard (ARNG) provide staff support and assistance in all training strategies pertaining to the RC. While the RC does not encompass all of the MI MOSs, those that it does have represent significant training challenges at all levels.
- Representatives of the national intelligence agencies and SMEs from units in the field also contribute throughout the development of each training strategy.

Developing the Training Strategy

Update (and develop where they currently do not exist) individual training strategies and programs of instruction for both the AC and RC in accordance with the Total Army Training System (TATS). Address individual training that is conducted both at the Intelligence School and in the unit. As a critical output, define the strategies for officer, warrant officer, and NCO self-development. The implementation of TATS will ensure AC and RC training is as seamless as possible, with differences being eliminated wherever possible.

—Intelligence Training XXI;
Ready Now²

Training comes from a variety of experiences that merit consideration in each cradle-to-grave training strategy. Each student's experiences will include some of the following:

- Initial entry training.
- NCOES training (particularly BNCOC and ANCOC).
- Warrant officer certification training.
- Officer Basic, Transition, and Advanced Courses, Command and General Staff College (CGSC) training and electives, the G2/Analysis and Control Element (ACE) Course, and the MI Pre-Command Course (PCC).
- Functional training courses.
- ASAS training.
- Non-proponent courses (such as the Battle Staff Course, the National Systems Development Program, and the Undergraduate and Postgraduate Intelligence Programs (PGIP)).
- Self-development training, including education via distance learning (DL).
- Civilian education.
- Experience in the field.
- "Life 101."

The priority for the establishment of the cradle-to-grave training strategies is in pages 24 through 31 of **Intelligence Training XXI: Ready Now**. At the start of each cradle-to-grave effort, the battalion responsible for the training strategy establishes a strategy development task force (TF). That TF includes representatives

from all of the elements identified above. There is no single surefire formula to develop a cradle-to-grave training strategy. However, there are several important steps to be included in the development process along the way.

The first step of each effort is mission analysis. The OCMI and other elements of the Futures Directorate thoroughly examine the MOS under revision and determine how many personnel are authorized in the MOS at each grade and at which units and echelons we assign those soldiers. They next project the size of the MOS and what the soldiers will be required to do over the next ten to twenty years. In other words, they analyze the current and projected force structure, describe the current and future missions of the MOS, and identify the battlefield operating systems the soldiers of that MOS will use now and into the foreseeable future.

Armed with that knowledge, the TF and SMEs from the field begin individual and collective task and mission analysis. After compiling a complete listing of tasks, conditions, and standards, they identify the critical tasks for each skill level from 10 through 40. Although no formal institutional training exists for the 20-level NCO, the listing includes critical tasks for the grade of sergeant.

Once that job analysis is complete, the TF crosswalks those tasks (training requirements) against the program of instruction (POI) for existing institutional training. In the initial MOS training strategies, the TFs identified a considerable number of additional tasks not presently taught by the Intelligence Center. The TFs also identified redundancy between some IET and NCOES training—redundancy that USAIC simply cannot afford to continue.

As each TF continues its work, it compares the existing training and the ideal future training to develop a plan that defines the training requirements at each grade level. They denote methodologies

for the training, identify the media and devices necessary to complete the training, and begin formulation of the written strategy and the accompanying decision briefing for the Deputy Commanding General (DCG). This comprises the complete redesign of resident training as well as training conducted by USAIC in non-residential classes.

Because of TRADOC restrictions on the number of new hours added to resident training, the TFs cannot use completely unconstrained thinking. In all cases where we want to add hours to a POI, USAIC must provide a "bill payer."

As a result of TRADOC's restrictions, the TFs included substantial amounts of nonresident training in the training strategies—most notably at the 20-level (between IET and BNCOC) and at the 30-level (between BNCOC and ANCOC). USAIC is not only incorporating this nonresident training into the written training strategies, but will also mandate completion of this training before an NCO may attend BNCOC or ANCOC. In other words, NCOs must take an active role in their careers to ensure completion of all prerequisites or they will not be permitted to attend further NCOES training.

In some cases, the nonresident training will be correspondence or on-line courses provided by an outside source. The National Cryptologic School (NCS) will serve as a major provider of nonresident training materials for soldiers in Career Management Field (CMF) 98. USAIC intends to leverage the vast resources of our national intelligence agencies to optimize training. The National Security Agency (NSA), the National Imagery and Mapping Agency (NIMA), and the Defense Intelligence Agency (DIA) can all provide substantive enhancement to the training of our soldiers, NCOs, and officers. For example, NSA and the NCS developed the successful Adjunct Faculty program (see page 47); the DIA,



U.S. Army photos

NIMA, and the Federal Bureau of Investigation are all developing similar programs.

Implementing and Tracking the Strategy

As the TF nears completion of its strategy, a senior steering committee provides a thorough review of the training strategy. The steering committee members include:

- Commander, 111th MI Brigade, and the Dean of IET.
- Director and the Dean of Continuous Learning.
- MI Corps Command Sergeant Major (CSM).
- Commander of the responsible training battalion.
- NCOA Commandant.
- OCMI.
- Chief of the Reserve Component Office (if the MOS under review is in the USAR or ARNG).

This intensive effort goes through each detail to ensure that the strategy is sound. Once the steering committee approves the recommended training strategy, the TF schedules and presents its decision briefing to the DCG.

After initial approval of each training strategy by the DCG, the battalion responsible for the training strategy schedules quarterly in-progress reviews with the DCG to brief the progress made in the development and execution of the training strategy. The battalion also will conduct annual curriculum reviews with the DCG to ensure that the dynamic training strategy remains current and on track for all MOSs as they progress into the 21st Century.

Finding the additional time and resources required to ensure that our MI soldiers and NCOs receive all of the training they require to serve ably at each level throughout a 30-year career is not an easy matter. Every new training strategy has significant demands for instructor personnel, class time, facilities, and monetary resources. The USAIC leadership is seeking the partnership of the Department of the Army Staff, TRADOC, national agencies, the U.S. Army Intelligence and Security Command (INSCOM), and the other Services to provide some of the resources necessary to enhance our training capabilities, both in-house and in nonresident training.

Conclusion

The training strategy development process outlined here is not a fast one—from start to finish a well-constructed training strategy takes the concerted efforts of the TF about six months. The initial results for the MOSs that have received DCG approval reflect considerable effort by the NCOs, warrant officers, and others comprising the TFs. Each decision briefing to date resulted in broken training paradigms. The value of the developmental effort for the cradle-to-grave training strategy far outweighs the time and effort involved.

Endnotes

1. *Intelligence Training XXI: Ready Now—1997 Action Plan*, USAIC&FH, undated.
2. *Ibid.*

Colonel Gramer was attending the Pakistani National Defence College but was evacuated with the other U.S. citizens. He was the first Director of Continuous Learning at USAIC&FH and has served as the OCMI. COL Gramer has had assignments in Bosnia, Panama, Honduras, Korea, and Hawaii. He holds bachelor and master of arts degrees in Spanish from the University of Colorado at Boulder. Readers can reach COL Gramer via E-mail at gkgjr@aol.com.



The 98C Career Training Strategy

U.S. Army photos

by Sergeant First Class
Michael C. Taylor

Through its **Intelligence Training XXI: Ready Now—1997 Action Plan**,¹ the U.S. Army Intelligence Center and Fort Huachuca (USAIC&FH) has embarked on a major review and overhaul of intelligence training. As part of this effort, the 305th MI Battalion formed a military occupational specialty (MOS) 98C (Signals Intelligence (SIGINT) Analyst) "cradle-to-grave" Working Group in March 1997. The Group's mission was to answer Objective 1.1² of the Action Plan by developing a 98C career training strategy (CTS) for the 21st Century. This article summarizes the results of the 98C Working Group that met in near continuous session from 12 November 1997 to 26 January 1998.

We defined "current" as fiscal year 1998 (FY98) and "future" as FY05. By FY05, the USAIC&FH will need to reevaluate and revise the 98C CTS to address the impacts of MOS restructuring, the continued digitization of the battlespace, and the fielding of new systems. We also assumed that a distance learning architecture of sites and media would become available to support self-development and as an alternative to resident training. The primary training sources for this architecture will be the USAIC&FH for Army intelligence training and the National Cryptologic School (NCS) for signals intelligence (SIGINT) training. Other enablers include access to training via the Active Component (AC) and Reserve Component (RC) training centers and readiness facilities.

Mission Analysis

The first step in developing the CTS was to define both the future operational environment and the training requirements. The mission analysis revealed several things about where 98Cs are today and where they will be in the future. There are now approximately 2050 AC 98C soldiers in the post-Change in NCO Structure (CINCOS) Army.³ The majority (73 percent) of AC 98Cs are in echelons above corps (EAC) Intelligence and Security Command (INSCOM) units. In the U.S. Army Reserve (USAR), 73 percent of the 124 USAR MOS 98C soldiers have EAC missions. More than 99 percent of the 263 MOS 98Cs in the National Guard are assigned to echelons corps and below (ECB) units.

<p>Assignment: RSOC - Traffic Identifier or Analyst ACE - SIGINT Analyst</p> <p>Proficiency: Apprentice Analyst Basic ASAS-SSW Operator</p> <p>Competency: Reconstruct single-channel net/network Reconstruct a multichannel network Perform crypto-traffic analysis Perform basic cryptanalysis Incorporate collateral and open-source information Perform OPELINT analysis Perform electronic preparation of the battlefield Prepare time-sensitive reports Prepare asset status, tasking, or effectiveness reports Operate a LOOKING GLASS workstation Operate an ASAS-SSW</p> <p style="text-align: right;">98C10</p>	<p>Assignment: RSOC - Senior Analyst or Reporter ACE - Team/Shift NCOIC TRADOC - IET Instructor/Writer</p> <p>Proficiency: Master Analyst Journeyman Reporter and CM NCO Senior ASAS-SSW Operator</p> <p>Competency: Reconstruct nonmilitary or nondoctrinal net/network Perform C²W target value analysis Quality control and release a CRITIC Prepare SIGINT summaries and graphic SIGINT reports Prepare non-codeword and tearline reports Develop and maintain SIGINT collection plan Assess electronic attack capabilities Develop SIGINT specific orders and requests Prepare ITDB CONMSG and POEREP Perform ASAS-SSW applications management</p> <p style="text-align: right;">98C30</p>
<p style="text-align: right;">98C20</p> <p>Assignment: RSOC - Traffic Analyst ACE - SIGINT Analyst</p> <p>Proficiency: Journeyman Analyst Apprentice Reporter and CM NCO Basic ASAS-SSW Operator</p> <p>Competency: Reconstruct multimode net/network Perform C² target value analysis Quality control time-sensitive reports (less CRITIC) Prepare a finished SIGINT reports Prepare technical reports, working aids, and messages Prepare resource status reports Task or request SIGINT collection or electronic attack Manage and troubleshoot ASAS-SSW event alarms</p>	<p style="text-align: right;">98C40</p> <p>Assignment: NSA - Senior Analyst or Watch NCO ACE - SIGINT Team NCOIC (Division) CM NCO (Corps)</p> <p>Proficiency: Master Analyst, Reporter, CM NCO ASAS Master Analyst</p> <p>Competency: Perform basic computer-to-computer network analysis Quality control and release a product and tech reports Validate SIGINT collection and attack requirements Develop SIGINT specific information requirements Coordinate SIGINT dissemination architecture Evaluate SIGINT reporting Develop SIGINT collection strategy</p>

Figure 1. The 98C Skill Requirements.

The majority of 98C10, 98C20, and 98C40 soldiers are and will be at national-level sites. Division of the 98C30s is roughly even among echelons, and they also have a significant presence in U.S. Army Training and Doctrine Command (TRADOC). Most of the 98C50s serve in positions in ECB units. The Working Group also examined the impact of future force structure, threats, and technology on MOS 98C and determined the following.

Force Structure. Junior enlisted soldiers and NCOs will need higher skill proficiencies and will need to embrace leadership responsibility earlier due to the reduction of NCO strength under the CINCOS and MI restructuring.

This means, for example, that the 98C10 analysts in ECB units will perform many of the duties that 98C20s currently perform. MOS 98C will also assume a greater responsibility for operational electronic intelligence (ELINT) analysis and reporting under a potential future restructure of MOSs 98C and 98J.

Threat Environment. Analysts will have to adapt analytical techniques and procedures rapidly to analyze and report on targets for which no database exists or targets that possess advanced information systems technologies. At ECB, the use of signals parametric data will increase as access to text for encrypted traffic and voice analysis declines. Many threat

targets will exceed the capabilities of organic ECB intelligence and electronic warfare (IEW) assets. Therefore, collection management (CM) will require a solid understanding of EAC collection and processing assets to fully support the tactical commander.

Technology. The use of parametric data and the increased digitization of the battlespace will enable icon-based analysis and reporting about threat information systems, networks and time-sensitive combat information. Improvements in U.S. technology and the operating tempo of the modern battlefield potentially will give the 98C10 analyst the ability to dynamically task organic assets and possibly non-organic

ones, including those at national level. At EAC, the analysis and reporting about more advanced information networks will increase with threat technology proliferation. The use of graphic SIGINT reports will increase as production capability, experience, and customer demand increase.

Training Review

After identifying what the future holds for 98Cs, the Working Group identified future skills (performance) and knowledge requirements for each competency area (analysis, reporting, and CM) by echelon and by MOS skill-level. The Group then compared both the current and future needs of echelons to determine the baseline requirements for each skill-level. The comparison resulted in the following skill-level assessments and training requirements depicted in Figure 1. (See the glossary on pages 62 through 64 for the expansions of the acronyms.)

98C10. The overall proficiency level remains **apprentice** between FY98 and FY05. However, there are increased performance requirements for time-sensitive reporting, operational ELINT, and the Na-

tional Security Agency's LOOKING GLASS workstation. Likewise, knowledge requirements increase in the areas of threat technology and Army IEW doctrine.

98C20. The Working Group saw a need for the overall proficiency level to increase from apprentice in FY98 to **journeyman** in FY05. Skill requirements increase in the areas of multimode and multi-echelon communications intelligence (COMINT) analysis, as well as in the area of radar and weapons correlation to specific echelons or organizations for ELINT analysis purposes. The 98C20 should be capable of drafting SIGINT reports and performing basic asset management.

98C30. The Group recognized a need for the overall proficiency level to increase from journeyman to **master** analyst. The 98C30 is the linchpin position within the MOS and has multiple roles: instructor, analyst, reporter, CM NCO, and supervisor. These NCOs must be highly proficient in all aspects of SIGINT operations, particularly in adapting standard analytical techniques to attack nonstandard target sets. The 98C30 must also be competent at Army CM and

capable of performing limited national-level CM within the unit.

98C40. Again, the overall proficiency level must increase from journeyman to **master**. Primarily assigned to national-level organizations, the 98C40 applies experience, skills, and knowledge to supervise analysis, publish reports (technical and graphic products), and manage the SIGINT collection effort. With a large role in theater army CM, this analyst must be highly proficient at Army CM and capable of working with or gaining support from national and joint assets. At theater army and below, the 98C40 is the All-Source Analysis System (ASAS) Master Analyst for the SIGINT team in the analysis and control element (ACE).

98C50. Master analysts, the majority of 98C50s, work in ECB units supervising or supporting SIGINT operations as an ACE SIGINT team NCO in charge (NCOIC), battalion or brigade operations sergeant, or first sergeant. In EAC units, these NCOs use their knowledge and experience to supervise SIGINT operations, coordinate collection, and develop SIGINT training.

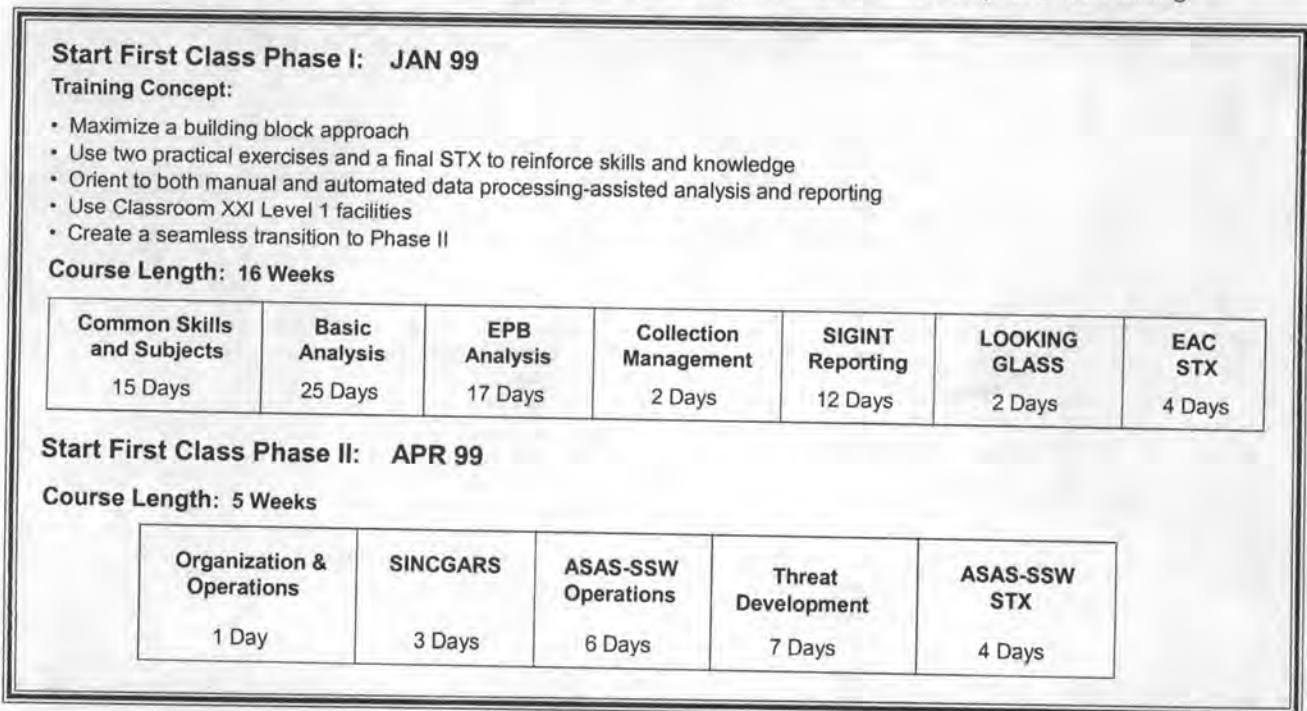

Figure 2. The 98C IET (Phases I and II) Training Plan.

Training Plans

From the mission analysis and the requirements captured in Figure 1, the Working Group and training developers drafted new programs of instruction, self-development plans, and training concepts. After course validation, each resident course will undergo a feasibility study to determine its potential for exportation and execution at RC training sites. The following information provides an overview of the training envisioned for each 98C by skill-level.

98C10 Initial Entry Training.

The 98C Initial Entry Training (IET) consists of two phases: Phase I at Goodfellow Air Force Base (AFB), Texas, and Phase II at Fort Huachuca, Arizona. The Phase I course trains AC and RC soldiers to perform basic SIGINT analysis and to report at all echelons using manual and automated techniques and procedures. In Phase II, the soldiers learn to perform apprentice-level SIGINT analysis and reporting in a corps- or division-level ACE equipped with the ASAS Single-Source Workstation (ASAS-SSW).⁴ Completion of Phase II (formerly the Electronic Warfare Analyst Course) is mandatory for the award of MOS 98C10 to both AC and RC soldiers.

The new Phase I IET course is based on the Army basic analysis and reporting curriculum approved by the NSA Cryptologic Training Advisory Committee (CTAC) and the results of the 98C Working Group. The modular course will develop cognitive skills and emphasize fundamental analytic skills. The course will also introduce soldiers to NSA LOOKING GLASS applications and to the Intelligence Center's Korean Common Scenario. Course development will take place during FY98 with a projected course start date in January 1999. Figure 2 presents an overview of the FY99 course.

Start First Course: OCT 98

Training Concept:

- Use NCS courses
- Complete within two years of enrollment
- Eligible at specialist
- Required at sergeant-promotable
- Pre-enrollment requirement for BNCOC in OCT 00

Course Flow: Two years

Module 1 Analysis	Module 2 Reporting	Module 3 Collection Management
63 hours	28 hours	26 hours

Figure 3. Journeyman SIGINT Analyst Course.

The new **Phase II IET** course will start in April 1999, approximately 16 weeks after the new Phase I course begins. Training will be performance-oriented and employ the Korea-based scenario from beginning to end. The scenario and end-of-course situational training exercise (STX) will be a continuation of the Korean Common Scenario begun in Phase I; the focus, however, will be on divisional IEW operations, pre-hostilities, and transition to war. The course will certify soldiers as basic ASAS-SSW operators and apprentice-level SIGINT analysts. Figure 2 also depicts the structure of the Phase II course.

98C20 Self-Development Training.

The primary objective of the 98C20 self-development plan is to train a specialist on the technical skills and knowledge needed to be a sergeant. A secondary objective is to ensure that the promotable sergeant arriving at the 98C30 BNCOC is competent in 98C20 tasks and prepared to learn 98C30 skills. Under the plan, the soldier is responsible for completing the Journeyman SIGINT Analyst Course (see Figure 3) within two years of enrollment. The course is a self-paced, modular, distance learning curriculum, which will be available through the Army Correspondence Course Program

Start First Class: MAR 99

Training Concept:

- Assumes students possess 98C10 and 98C20 skills and knowledge
- Teach skills through "knowledge, practice, apply" technique
- Evaluate students' applied skills
- Challenge students to think via a non-doctrinal threat scenario
- Produce a master SIGINT analyst and a journeyman reporter and collection manager

Course Flow: 16 Weeks

Common Core	EAC Scenario	ECB Scenario
17 Days	46 Days	17 Days

Figure 4. The 98C30 MI BNCOC Training Plan.

in October 1998. Once the program's content and delivery mechanisms are firmly in place, the Journeyman SIGINT Analyst Course will become a pre-enrollment requirement for attending 98C30 BNCOC.

students will employ their newly acquired skills and knowledge in a challenging non-doctrinal scenario

98C30 Basic NCO Course.

The new 98C30 BNCOC, which begins in March 1999, will train mid-career SIGINT NCOs to conduct and supervise multimode analysis, reporting, and CM at EAC and ECB. The proposed course applies the NSA CTAC-approved Army intermediate analysis and reporting curriculum in an innovative instructional environment. In this "knowledge, practice, and apply" environment, the students will employ their newly acquired skills and knowledge in a challenging non-doctrinal scenario. Using the scenario, we will attempt to challenge students beyond their abilities, require individual execution, and not force a single "schoolhouse" solu-

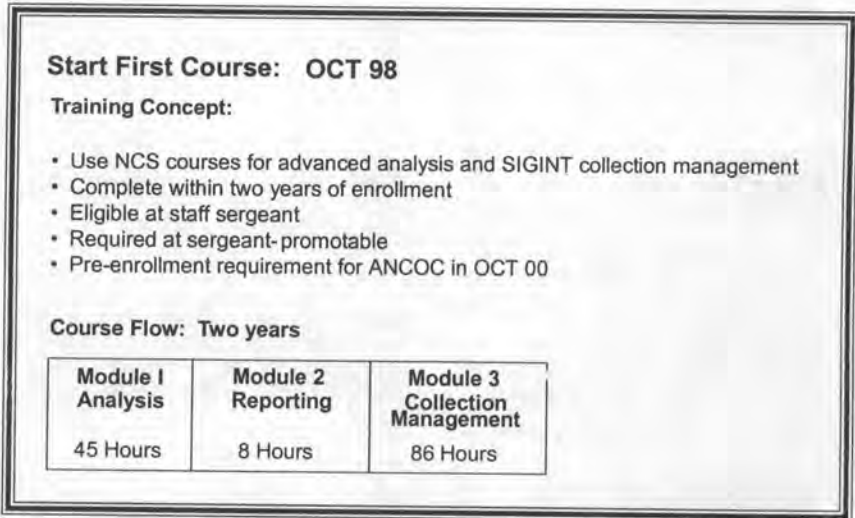

Figure 5. Master SIGINT Analyst Course.

tion. On completion of the course, the NCO will be a master SIGINT analyst and a journeyman-level reporter and collection manager. Figure 4 depicts the basic structure of the proposed 98C30 BNCOC. See First Sergeant Timothy Carroll's article (page 36) for further course details.

98C30/40 Self-Development Training. The objective of the 98C30/40 self-development training is to provide staff sergeants and sergeants first class with advanced-level technical training. Like the 98C20 program, the 98C30/40 training will be an Army Correspondence Course consist-

ing of NCS courses grouped into modules. Once fully refined and emplaced, the Master SIGINT Analyst Course will become the 98C40 pre-enrollment requirement for ANCOC. The challenges for this training will be in keeping pace with the innovative issues in SIGINT analysis and ensuring accessibility to the training. Both the 98C20 and 98C30/40 self-development training will require close cooperation with the NCS to meet this challenge. Figure 5 shows the basic strategy and modules for the Master SIGINT Analyst Course.

98C40 Advanced NCO Course.

Promotable staff sergeants will attend the resident MI ANCOC at Fort Huachuca. The advanced course will provide realistic, multidiscipline training for senior NCOs in Career Management Fields 33, 96, and 98. Using a realistic and challenging training environment, the course's objective is to produce information age warriors in tasks common to all senior MI NCOs. Figure 6 presents the ANCOC course under development for FY98.

Conclusion

Developing a career training strategy is no easy task and it cannot happen in a vacuum. With this in mind, the Working Group gathered and applied the thoughts, analysis, requirements, and hard

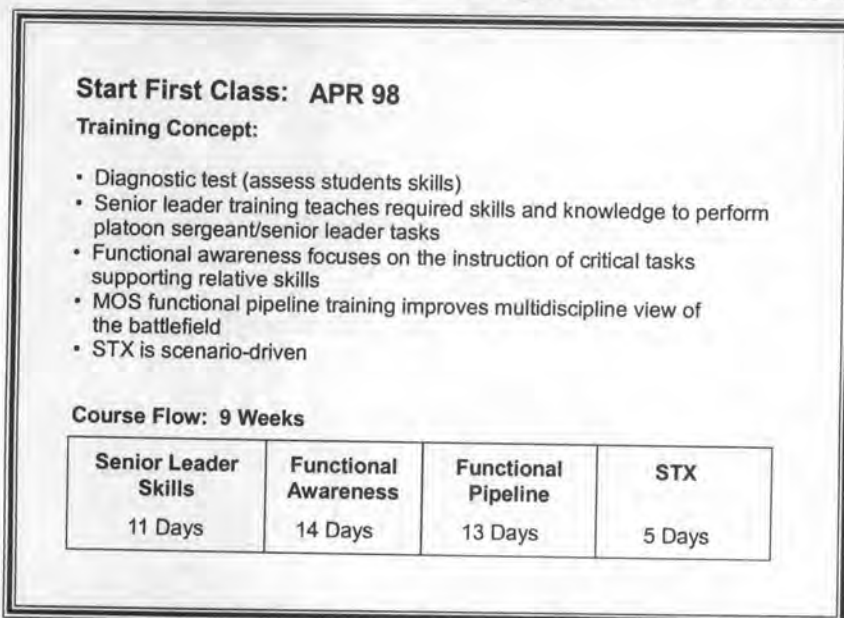

Figure 6. The 98C40 ANCOC MI Training Plan.

work of intelligence professionals from throughout the U.S. Army and the national cryptologic community. Additionally, the Group's conclusions and recommendations underwent scrutiny in several subject matter expert review boards and during two general officer-level briefings. To be successful, however, soldiers and leaders in the field must understand and support the 98C career training strategy. This article will help build that support by serving as a catalyst for future discussion on 98C training for the 21st Century.

Endnotes

1. **Intelligence Training XXI: Ready Now—1997 Action Plan**, USAIC&FH, undated.
2. Ibid. Objective 1.1 is to "revise, update, and improve individual intelligence training strategies for both the Active Component (AC) and the Reserve Component (RC) to enable continuous professional development from service entry to retirement."
3. Sergeant Major Patricia A. York, "Career Forecast for the MI Enlisted Force," **Military Intelligence Professional Bulletin**, January-March 1998.
4. Sergeant First Class Michael C. Taylor, "Training a Better Analyst," **MIPB**, July-September 1997.

Sergeant First Class Taylor is currently a doctrine writer and the NCOIC, Doctrine Division, Futures Directorate, at Fort Huachuca, Arizona. He chaired the 98C Working Group while in A Company, 305th MI Battalion. An NSA Professionalized Traffic Analyst, he has served as a SIGINT analyst at national, theater, division, and brigade levels. He was the primary writer for FM 34-1, Intelligence and Electronic Warfare Operations, and FM 34-25-3, All-Source Analysis System and the Analysis and Control Element, as well as a former Editor of MIPB. SFC Taylor has a bachelor of arts degree in Russian Studies from the University of Maryland. Readers can reach him telephonically at (520) 538-0959 or DSN 879-0959 or via E-mail at taylorcmc@huachuca-emh1.army.mil.

(CSM FORUM Continued from page 3)

- Realism.** Realism must be a primary requirement and intelligence training must replicate reality, both in frequency and in scope. The ability of intelligence to satisfy the commander's time, precision, and synchronization requirements must be reproduced and also stressed in realistic training.
- Proficiency.** MI and the 21st Century Army will require a

truly proficient force—one that must be able to demonstrate its proficiency under more difficult conditions.

These three training imperatives have firmly incorporated training development principles and core competencies and have allowed us to complement them with a series of goals and objectives for accomplishing the intended training outcomes. There are many inno-

ventions and improvements happening at Fort Huachuca, and I am excited to be able to be a part of them. I encourage each of you to get involved, to be a part of the solution, and to help us move intelligence into the 21st Century.

As always, train hard, take care of soldiers and their families, and have fun. Thanks!

ALWAYS OUT FRONT!

Military Intelligence
PROFESSIONAL BULLETIN

Order Processing Code
*6489



Subscription Order Form

Charge your order.
It's easy!



Please send me _____ subscription(s) for _____ year(s) for the **Military Intelligence Professional Bulletin**. \$7.50 (Domestic, APO, and FPO); \$9.40 (Foreign) per year.

1. The total cost of my order is \$_____. All prices include regular domestic postage and handling and are subject to change. I understand this charge is not refundable.

2. _____
(Company or personal name)

(Street address)

(Additional address/ Attention line)

(City, State, ZIP Code)

3. Please indicate method of payment:

Check payable to the Superintendent of Documents

GPO Deposit Account No: _____

MasterCard VISA Discover exp. date _____

Authorization Signature _____

4. Mail to:
Commander, U.S. Army Intelligence Center and Fort Huachuca, ATTN: ATZS-CLM, Fort Huachuca, AZ 85613-6000



Photos courtesy of the author.

33W Training Strategy

by Sergeant Major Frank Liebsch

During the past year, the USAIC&FH has been conducting a series of MOS "cradle-to-grave" analyses. The analysis of MOS 33W (Electronic Warfare/Intelligence Systems Repairer) was conducted under the direction of the Deputy Commanding General, Brigadier General John W. Smith, and in accordance with **Training and Doctrine Command (TRADOC) Regulation 350-70, Training Development Management, Processes, and Products**. In essence, we analyzed the missions, collective tasks, and individual tasks of all military intelligence units, IEW systems, and 33W soldiers at each skill level. We then developed our training strategy.

Preparatory Analyses

Force Analysis. This analysis helped us to develop a greater awareness of the current and changing Army intelligence structure and missions. The analytical results were many, but here I highlight just a few:

- The number of 33W soldiers in the force structure will decline from 976 to 901.
- There are about 95 units with an IEW maintenance role.

- The number of IEW systems that 33W soldiers maintain exceeds 50.
- All depot-level 33W maintenance positions became civilian slots.
- Doctrine contains too little about IEW maintenance.
- There is a shortfall in training products to support IEW maintenance.

The 33W cradle-to-grave Working Group comprised more than 20 members—primarily noncommissioned officers (NCOs)—who brought a wealth of experience and a variety of backgrounds into the analysis process. Also present were civilians and soldiers who brought expertise in training development, computer maintenance, and combat developments.

Following the TRADOC model for analysis, the Working Group obtained supporting materials such as the:

- U.S. Total Army Personnel Command (PERSCOM) Enlisted Strength Inventory Report.**
- Fiscal Year 2000 (FY00) Personnel Manning Authorization Document (PMAD).**
- FM 34-1-1 (Draft), IEW Systems Handbook.**

- FM 34-1, Intelligence and Electronic Warfare Operations.**
- FM 100-10, Combat Service Support (CSS).**
- The 34 A-Series Table of Organization and Equipment (TO&E).**
- FM 9-43-1, Army Maintenance Operating Procedures.**
- AR 750-1, Army Materiel Maintenance Policies.**

We also reviewed System Training Plans (STRAPs), Qualitative and Quantitative Personnel Requirements Input (QQPRI), Basis of Issue Plans (BOIPs), Life Cycle Support Plans (LCSPs), and many other sources of information. Our challenge was to boil all this down into useable information upon which to base decisions on training strategy regarding soldiers in MOS 33W.

First, we developed a tool that shows us a footprint of the IEW systems in the force structure. The chart (see Figure 1) gives us a bird's eye view of where the 33Ws work, the systems on which they work, and how many soldiers are available for these jobs.

Mission Analysis. Next, we analyzed our missions. We listed our missions by the levels of authorized maintenance according to Army maintenance doc-

	TOE UNITS													TDA UNITS														
	33W MAINT	AE BN	AE BN	OPS BN	OPS BN	MI BN	MI BN	MI BN	MI BN	AA BN	AV	SPE COC	CEW I PLT AV	MI CO BN	MI BN	MI CO BN	ORD	HHC CO	TNG	TNG	USAREC	MI BDE EAC	MI BN	AE BN	SPECIAL UNITS	NETT R & D TEST		
TOE SYSTEMS																												
Number of Units		2	1	1	2	2	6	1	1	1	6	15	5	5	1	3	3	4		4	3	3	3	1	1	4		
Number of Soldiers		12	38	28	11	24	90	15	23	23	12	15	10	29	15	36	41	8		25	1	33	0	4	2	62		
ACS (2008)																												
GRCS	X		O	O												O												
ARL	X		X	X																R								
AHFEWS																				R								
AMSS	X															X				J								
AQF (2001)																												
QUICKFIX	O					O	O	O	O	O						O				R								
ASAS	X					X	X	X	X	X						X				R								
DTSS	X	X	X	X	X	X	X	X	X	X						X	X			R/J			X	X	X			
E-TRACKWOLF	35	O	O	O	O	O	O	O	O	O						O	O						O	O	O			
FAST	X																			J								
GSR																				?								
IEWCS/GBCS-L/H/AQF (1999)	35D																											
TEAMMATE	O					O	O	O	O	O						O				R								
TRAILBLAZER	X					X	X	X	X	X						X				R								
IMETS	X					X	X	X	X	X						X				R								
IEMBASS	AF	X	X	X	X	X	X	X	X	X						X												
JSTARS-CGS/GSM	35C																											
JTH3	X	X	X	X	X	X	X	X	X	X						X	X			R			X	X	X			
CTT	O	O	O	O	O	O	O	O	O	O	O	O	O	O	O	O	O	O		R			O	O	O			
LMRDFS	X	X	X	X	X	X	X	X	X	X										J								
TES	X					X	X	X	X	X	X									J								
EPDS/ETUT/AEPDS				O	O															?			O	O				
ETRAC	X																			J								
MITT	X			X	X															J								
MIES	X						X													J								
TRACKWOLF	X			X	X															J				X				
TROJAN CLASSIC	X																X			J								
TROJAN SPIRIT	X															X				J			X	X				
TRRIP	31U					X	X	X	X	X													X	X				
UAV-T/SR							X	X	X	X																		
UAV-E	X					X	X	X	X	X										R								
TDA SYSTEMS																												
ASAS-SS																												
ASM	X															X				R								
BIKEWAY	X																			J								
BIRDSNEST	X																			J								
CHAINWORK	X																			J			X	X	X			
CHRYSALIS	X																			R			X	X	X			
CINIMATE	X																			R/J			X	X	X			
CLEANSLATE	X																			J								
COOLSPOT	X																			J								
CRS	X																			J								
CSU	X																			J								
EAGLE REACH	X																			J			X	X	X			
EARGERNESS	X																			J								
GLADLY	X																			J								
ICDH	X																			J								
ICEFALL	X																			J								
KAINITE	X																			J								
LANSMAN KRAKEN	X																			J								
LOOKING GLASS	X																			J								
MONGOOSE	X																			J								
MONOCLE	X																			J								
NIGHTGLOW	X																			J								
NITPIC	X																			J								
PARSEC	X																			R								
PUSHER	X																			R								
QUICKSILVER	X																			J								
ROCKERTEER	X																			J								
SANDSAILOR II	X																			J								
SOUNDER	X																			J								
SSRW	X																			J								
SUGERFOOT	X																			J			X	X	X			
SUPERCODING	X																			J								
SWEEPSTAKES	X																			J								
TOLLHOUSE	X																			R/J								
TOPAZ	X																			J								
TOPSOIL	X																			J								
TRACECHAIN	X																			J								

Figure 1. IEW System Footprint on the Force.

trine. We also observed that we had no mission training plans (MTPs) to support IEW maintainers; thus we had no document to illustrate our collective tasks. We created our own. We defined seven collective tasks (see Figure 2) that are unique to IEW maintenance sections. We also identified 25 additional collective tasks that we will include in our own proposed MTP (to be numbered **Army Training and Evaluation Program (ARTEP) 34-33-MTP**). At about that point in time, we learned that all the 33W depot positions were undergoing conversion to civilian labor.

The proposed MTP would help drive content and standards in IEW maintenance section's standing operating procedures (SOPs). The collective tasks and their standards will also be included in **ARTEP 34-113-11/12, MI Collective Task Standards (MTP)**, so that commanders, their staffs, and MI units can better evaluate their IEW maintenance sections. We will also develop the training support plans (TSPs) for each IEW system. The TSP is a lesson plan for conducting training. It identifies necessary resources and provides visual aids and lesson guides and outlines for use by the unit in conducting maintenance training classes on their particular systems. We will make these TSPs available on the LINK33 Internet homepage¹ and to other homepages whose missions are to support our IEW systems. LINK33's Internet address is <http://mtdadmin.army.mil>.

Job Analysis

We continued to analyze our collective tasks by writing conditions and standards with performance measures. This not only helped us to illustrate for the units the elements on which they will be evaluated, but also aided in determining the supporting individual leader and soldier tasks. We then reviewed the list of individual tasks; we adopted additional individual tasks and modified others. Ultimately, we concluded

Collective Tasks	Tasks #	Missions		
		UNIT	UNIT	UNIT
Repair systems at maintenance facility	34-4-XXXX	X	X	X
Repair forward deployed systems	34-4-XXXX	X		
Perform PMCS	34-4-XXXX	X		
Perform TI and EVAC	34-4-XXXX	X	X	X
Control repair processes	34-4-XXXX	X	X	X
Quality assurance operations	34-4-XXXX		X	X
Integrate systems into MI units	34-4-XXXX		X	X

Figure 2. Collective Tasks Unique to IEW Maintenance Sections.

this job analysis phase by delineating the skills and knowledge required to accomplish the individual tasks. Figure 3 illustrates the general skills and knowledge (S/Ks) by S/Ks level. A more detailed list contains more than 150 skills and knowledge elements.

Considering the merger of our three legacy MOSs—33R (Aviation Systems Repairer), 33T (Tactical Systems Repairer), and 33Y (Strategic Systems Repairer)—into one, the database for these tasks, skills, and knowledge is enormous and impossible to dis-

play in a concise format. Suffice it to say that with more than 375 individual tasks, we have a tremendous training challenge.

Individual Training Strategy

We took very seriously the Army's training doctrine that directs a Combined Arms Training Strategy (CATS) approach consisting of three pillars for individual training:

- Institutional or resident training.
- Unit-conducted training.
- Self-development training.

33W SOLDIER	
10 Level (Apprentice)	30 Level (Senior)
Operate TMDE	Operate TMDE
Perform circuit measurements	Analyze equipment functions
Analyze circuits	Repair and maintain servers
Analyze equipment functions	Network maintenance
Computer systems	Mechanical repair
Diagnose IEW systems	Maintenance management
Mechanical repair	
Complete maintenance operations	
Field maintenance operations	
.....	
20 Level (Journeyman)	40 Level (Master)
Operate TMDE	Operate TMDE
Analyze equipment functions	Analyze networks/systems
Computer systems and networks	Analyze network equipment
Mechanical repair	Network management
Lead maintenance support teams	Maintenance management
	Intelligence communication
	Architecture

Figure 3. General Skills and Knowledge Required of a 33W.

The final phase in the cradle-to-grave analysis process was to identify the appropriate "pillar" (where each task should be taught) and the products needed to support that training. The "where" part of this decision was driven by resources, complexity, commonality, and criticality.

The training product might be a lesson plan in a resident course, a TSP for a unit-conducted training class, or a distance-learning package, such as interactive multi-media instruction, Army Correspondence Course Program (ACCP) booklets, or Internet interactive courses for self-development training. This last phase is crucial to the success of our overall training strategy. However, we need "hooks" in the plan that will ensure that each portion of a training strategy is enforceable. Figure 4 illustrates the progression of training mile-stones throughout the 33W soldiers' careers.

Distance Learning Program. The "hooks" mentioned earlier must make the Distance Learning Program (DLP) a prerequisite for a subsequent course, either an NCO Education System (NCOES) class or another DLP course. For MOS 33W, we chose to aim for the Basic and Advanced NCO Courses (BNCOC and ANCOE respectively) as the hooks. Completion of the 33W10 DLP course would be a prerequisite to entering the 33W20 DLP course, which would be mandatory for selection to attend the 33W BNCOC. Completion of the 33W30 DLP would be required for attendance at the 33W ANCOE.

One of the challenges in this situation is enforcement of the prerequisites. How would one screen and verify compliance with prerequisites? The Army Training Resources and Requirements System (ATRRS) documents all training courses that a soldier is

attending or has completed. We can add our DLP courses to ATRRS, and use that system to track enrollment and completion. The hook is that the PERSCOM career managers would ensure that the soldier has completed the appropriate DLPs as a prerequisite for BNCOC or ANCOE. We would also update the course administrative data for BNCOC and ANCOE to reflect that completion of the appropriate DLP was a prerequisite for selection. While we can currently amend the prerequisites for attending BNCOC or ANCOE, we cannot keep promotion boards from selecting personnel for promotion who have not attended these NCOES courses.

This is our **greatest challenge: can we convince the personnel propensity to amend its promotion selection policy?** We need to convince them that for MOS 33W, NCOs must complete the DLP for their skill levels be-

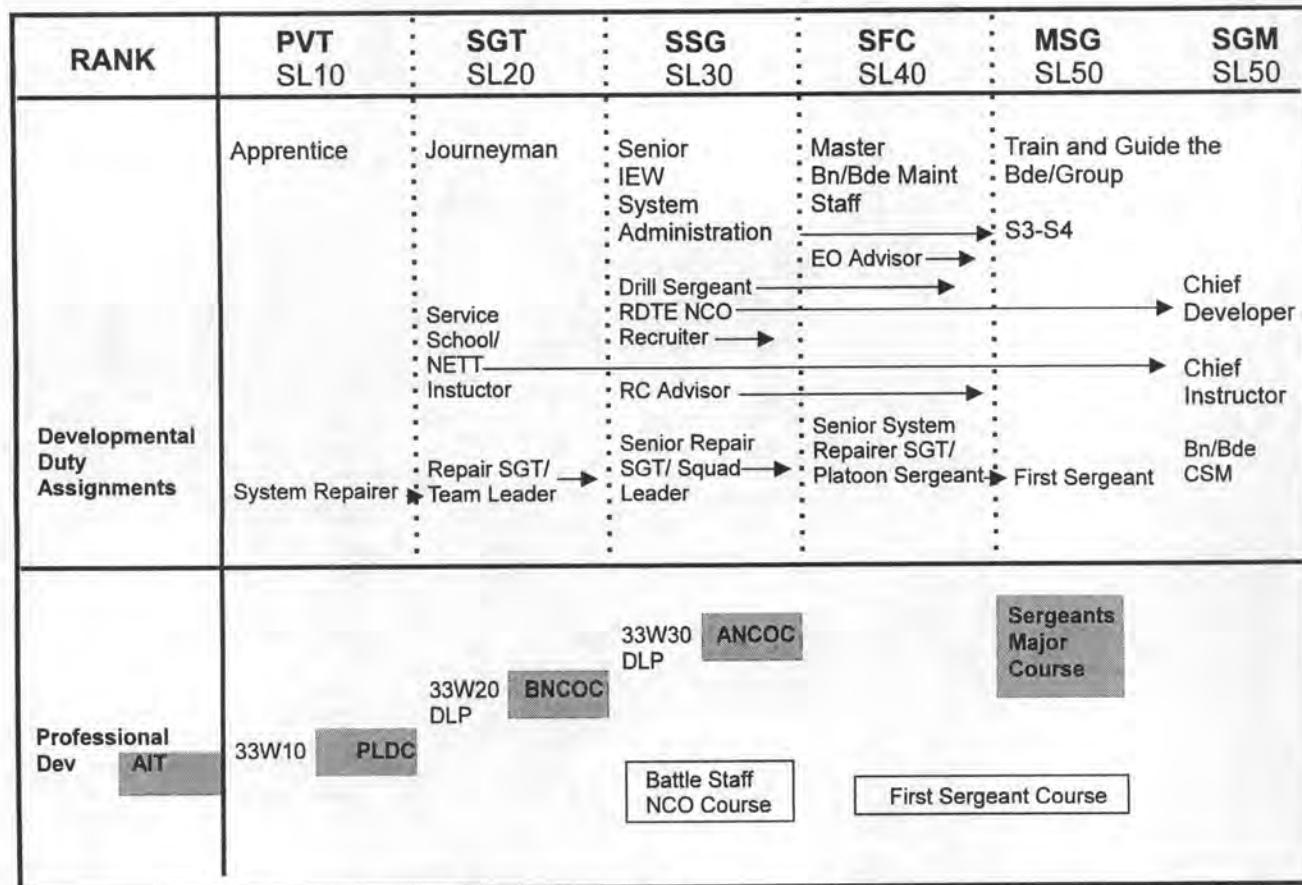

Figure 4. MOS 33W IEW Systems Repairer.

fore their appearance at a promotion selection board.

To take advantage of and leverage the Army's new distance learning programs, we must put teeth into the usage of these resources called distance learning. The cost of resident training, in terms of time and resources, mandates that the Army embraces this training technology. CATS mandates that we fully use all three pillars of individual development, and that development is a continuous process throughout the career of a soldier. Until now, it seems as if we have made that process an optional one. Figure 4 shows what we are working toward under the CATS model.

For our part at the Intelligence Center, we have three very progressive resident training courses planned for soldiers in MOS 33W. A review of 33W advanced individual training (AIT), BNCOC, and ANCOC highlights follow.

33W Advanced Individual Training. The new course is just over 41 weeks long. It will include a streamlined version of basic electronic maintenance principles (sometimes confused with theory), a strong emphasis on computers (mainframes, personal computers, high-performance workstations (HPWs), and networks), and a robust set of IEW systems. These systems include Guardrail Common Sensor, the AN/TRQ-32 (V) TEAMMATE, QUICKFIX heli-

borne special purpose countermeasures, AN/TLQ-17 TRAFFICJAM countermeasures set, and the Joint Surveillance Target Attack Radar System (Joint STARS). The course will also incorporate fiber-optic cable repair, All-Source Analysis System-Communication Control Set (ASAS-CCS) maintenance, and IEW Common Sensor (IEWCS) maintenance during the next three years.

33W BNCOC. The revised course will retain its technical portion of the radio frequency and analog measurement and analysis sections, as well as maintenance of the SUN HPW. The enhancement to the course will include fiber-optic cable repair and SUN HPW network maintenance. A special area of concentration will be server system administration. Future upgrades may include ASAS-CCS direct support maintenance training.

33W ANCOC. The modified course will feature HPW workstation and network maintenance training. The technical content of the course will also include telecommunications architecture for IEW system connectivity in the intelligence force structure. A special area of focus will be network system administration.

Summary

We have a training strategy for MOS 33W that will put a great onus on the unit and on the soldier for individual training. We will provide an MTP for IEW maintenance sections that will provide a basis for their mission



33W AIT soldier performing general maintenance tasks.

essential task list (METL)-based training program. We will have resident training courses that are and will continue to be current and modernized. We will have a self-development program that is accessible anywhere and anytime. We will have a system of TSPs that will allow a unit to conduct its own IEW system maintenance training based on its needs. With the right mix of training media, we can ensure continual development of the Army's best-trained and highly motivated maintainers—bar none.

Endnote

1. See the July-September 1996 issue of *MIPB* for a story about LINK33; that issue is on the Internet at <http://huachuca-usaic.army.mil/contlearning/infrastructure/media/mipb/index.htm>.

Sergeant Major Liebsch is the NCOIC of the IEW Maintenance Training Department, B Company, 305th MI Battalion, 111th MI Brigade, Fort Huachuca. He has served in a variety of IEW maintenance leader positions at Field Stations Augsburg and Berlin, and Kunia Regional Signals Intelligence (SIGINT) Operations Center. He has served as an instructor for the Maintenance Training Department at the U.S. Army Intelligence School Detachment, Fort Devens; Training NCO, Assistant Deputy Chief of Staff for Operations-SIGINT at Headquarters, U.S. Army Intelligence and Security Command; and First Sergeant, Maintenance Company, and 711th MI Battalion, 701st MI Brigade; Sergeant Major, 305th MI Battalion, 111th MI Brigade. SGM Liebsch has an Associate of Arts degree in General Studies from Central Texas College. Interested readers can contact him at E-mail liebschf@huachuca-emh1.army.mil and telephonically at (520) 538-7725 or DSN 879-7725.

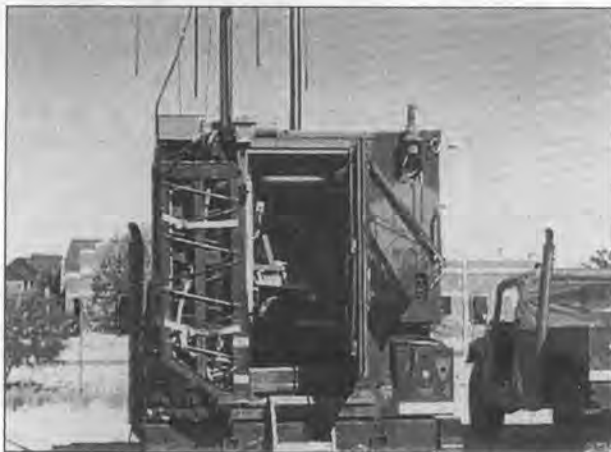

TEAMMATE set up to aid 33W AIT soldiers in a practical exercise to repair TEAMMATE systems.

Signals Collection/Identification Analyst (98K) Training

by Chief Warrant Officer Three
Katherine I. O'Neal and
Warrant Officer One
Keith J. Merryman

Today's world has moved into an electronic information age. This information age provides the basis for examining how intelligence professionals operate within the global environment, across the spectrum of conflict from war to antiwar.¹ The virtual explosion of communications-related technology demands that the intelligence community not only keep pace with changes, but that we anticipate new directions, adapt our intelligence doctrine, and stay flexible to further change. Army XXI and Intel XXI operations require an intelligence force that is truly proficient—one that "can do" rather than one that merely understands in abstract terms what needs to be done. Intelligence professionals will have to demonstrate their proficiency under unprecedented, significantly more challenging conditions.

As part of the U.S. Army Intelligence Center and Fort Huachuca (USAIC&FH) Commanding General's comprehensive training strategy for the 21st Century—**Intelligence Training XXI: Ready Now**—we are addressing the challenges of changing technology in the 98K military occupational specialty (MOS). The 98K (Signals Collection/Identification Analyst) performs and supervises collec-

tion, identification, exploitation, and analysis of digital and analog communications, to include voice, teleconferencing, videoconferencing, facsimile, computer-to-computer traffic, and telemetry. (See Figure 1 for a more specific listing of the required 98K skills. The glossary on page 62 expands the acronyms.)

Now, that is the "book" definition of a 98K. For the real message here, read **digital** Signals Collection/Identification Analyst.

Background

The 98K soldier traditionally focused on teleprinter and conventional non-Morse analog signals throughout the radio spectrum. Such was the target environment of the Cold War. The training these soldiers are now receiving has shifted to the meet digital signal and computer information age. Essentially, 98Ks will "break" digital signals into a recognizable form so that the 98C (Signals Intelligence (SIGINT) Analyst), 98G (Voice Interceptor), 98H (Communications Locator/Interceptor), and 98J (Electronic Intelligence (ELINT) Interceptor/Analyst) soldiers can further exploit the intelligence within the "digital envelope." As the communications environment continues to change rapidly from analog to digital, the 98K mission requirements have migrated from conventional collector to signals analyst and processor. The duty

requirements of 98Ks have become significantly more complicated and require more technically experienced personnel with a working, operational understanding of networks, computers, and digital systems. However, the existing training strategy is not meeting field requirements.

The resident training school for three 98K-related courses is the Navy Technical Training Center, Corry Station, Pensacola, Florida. These courses are 98K Advanced Individual Training (AIT), Intermediate Communication Signals Analyst Course (additional skill identifier M7), and the Advanced Communication Signals Analyst Course (ASI K2). The U.S. Navy is the Executive Agent for this training.

The current 98K AIT course (see Figure 2) is meeting, and will continue to meet, the challenges in today's digital communications environment for our junior enlisted 98Ks. The intermediate and advanced courses are producing competent leaders technically capable of performing all associated critical tasks. Unless the soldier is selected for an ASI-coded billet, however, the 98K may never see further resident technical training beyond the AIT course. Moreover, the lack of a prescribed 98K self-development technical training program creates a vacuum in which soldiers are left to their own devices to stay current while in the field.

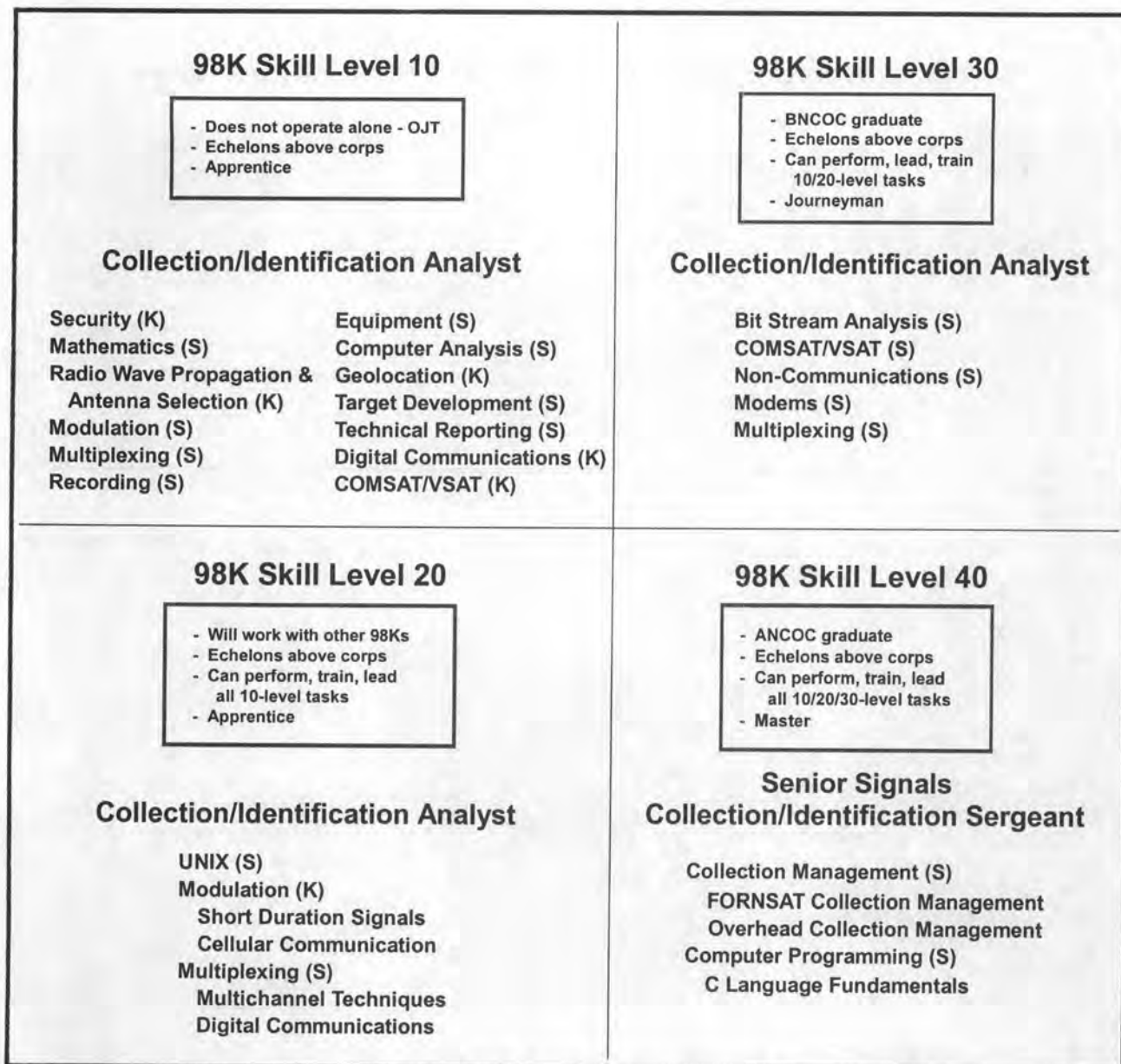

Figure 1. Skill and Knowledge Requirements for MOS 98K.

Elements of the 98K Training Strategy Development Plan

The 98K Training Strategy Development Plan, recently approved by the USAIC&FH Deputy Commanding General, calls for the following three elements:

- Nonresident self-development technical training before the Basic and Advanced Noncommissioned Officer Courses (BNCOC and ANCOC).
- Intermediate Communications Signals Analyst Course as the technical track for BNCOC.
- Development of a 98K technical track taught at ANCOC.

The first of these elements is completion of **nonresident self-development technical training** courses before attending the BNCOC and ANCOC. These courses will both reinforce resident training and prepare soldiers for it, bridging gaps and ensuring seamless training between each level of institutional training.

To execute this, we will capitalize on distance learning resources within the National Cryptologic School and the Intel-

ligence Center, and through the predominantly unclassified courses available via the National Security Agency (NSA) Dispatch II on the Internet. All of the classified portions are available at worldwide echelons-above-corps (EAC) SIGINT installations, such as the Regional SIGINT Operations Centers (RSOCs) and the Mission Ground Stations, where most 98Ks work. Soldiers must complete the nonresident program of studies before attending the resident NCO Education System (NCOES) courses. The Intelligence Center will provide

Communications Signals Collection and Processing Course 19 Weeks 4 Days

Mission: Teach the fundamental concepts of communications and techniques to produce a basic Signals Collection/Identification Analyst that can function effectively in today's rapidly changing signals environment.

Security 12 hours	Mathematics 37 hours	Radio Wave 16 hours	Modulation 26 hours	Multiplexing 19 hours	Recording 29 hours	Equipment 75 hours	Computer/Signals Analysis 343 hours	Geolocation 4 hours	Target Development 30 hours	Technical Reporting 62 hours
Digital Communications 61 hours			COMSAT (Communications Satellite) VSAT (Very Small Aperture Satellite [Terminal]) 14 hours				Simulated Field Operations 64 hours			

Figure 2. 98K AIT Course Flow.

the field training support packages (TSPs) outlining these self-development courses.

The second element of the training strategy is that the Intermediate Communications Signals Analyst Course (ASI M7) at Corry Station will become the technical track for BNCOC. This modification of the current BNCOC program will create a split-based training environment between Fort Huachuca, Arizona (where we will continue to teach the common core), and Pensacola.

This shift in training strategy will ensure that all 98K mid-grade NCOs are technically proficient, capable of assisting recent AIT-graduate "smart" soldiers, and able to make a relevant difference in the field. Under this new training strategy, the ASI M7 will cease to exist.

Finally, USAIC&FH will develop and implement a 98K ANCOC technical track to be taught at Fort Huachuca. While it may seem logical to adopt the existing ASI K2 Advanced Course at Corry Station as this technical track, the special skills taught in this course are simply not required in the field on as broad a scale as the intermediate course skills are for BNCOC graduates. The 98K ANCOC will focus heavily on collection manage-

ment skills, with reinforcement and expansion of computer programming skills as well.

Outlook

Once the new 98K training strategy is implemented, the ineffective selection process for ASI-producing schools will cease, and a seamless training architecture within the MOS will be established. These modifications in the 98K MOS career development training strategy mirror the current field technological trends and the newly emerging role of the signals collection/identification analyst. Service cryptologic elements and NSA representatives ensure institutional training requirements reflect field reality at periodic Cryptologic Training Advisory Committee forums. The true challenge is to smartly manage our two most precious assets, people and time. This "cradle-to-grave" training strategy identifies who will be trained **when** in their careers on **what** skills and knowledge. Both the institutional training base and field execution portions of this strategy will be critical.

As the duties and responsibilities of the 98K soldier expand to include counter-SIGINT (ASI 2G, taught at Fort Meade, Maryland), technical ELINT, foreign instrumentation signals intelligence (FISINT, ASI J1, taught at Fort

Huachuca), and information operations, the training requirements will continue to grow. We will place even greater technical and leadership responsibilities on our 98K NCOs. Leader development also includes promoting deserving soldiers. In a field where their digital communications skills are highly marketable in today's world, we need our 98Ks' commitment to the Army, the nation, and national security interests.

End Notes

1. *War and Anti-War: Survival at the Dawn of the 21st Century* by Alvin and Heidi Toffler (Little, Brown and Company, 1996).

Chief Warrant Officer Three O'Neal is currently stationed at Menwith Hill in England. She was the senior 352K (non-Morse Technician) and the Chairperson for the 98K "cradle-to-grave" Working Group. Her former assignments include positions at Army Field Stations Berlin, Kunia, and Augsburg, and at the Naval Technical Training Center (NTTC) at Corry Station. She is a graduate of Chaminade University.

Warrant Officer One Merryman was the Master Instructor for the Intermediate Communication Signals Analyst Course and a member of the 98K "cradle-to-grave" Working Group. His former assignments include positions at Army Field Stations Berlin and Kunia, Menwith Hill Station, and NTTC. He is a graduate of the University of Maryland with an associates degree in Education. He can be reached at (301) 688-0135 or DSN 644-0135.

Cradle-to-Grave Interrogator: Training Using an Embedded AI Device

by Major Jeffrey T. Girard

Currently, the military intelligence interrogation community does not have an automated training device. The training methodology used is a manual system in which the instructors role play a "subject" for the students to interrogate. This system has three significant disadvantages. The first is the overhead in having instructors or other role-players memorize scripts. The second is the language barrier since the students cannot interrogate in their target languages. The third is the inability to make the training session dynamic by integrating it with simulations.

In this article, I propose the four-phase creation of an artificial intelligence (AI) device for interrogators. This system will provide more realistic training, while simultaneously improving the accessibility of sustainment training through distance learning. This system will enable Army Reserve and National Guard soldiers, personnel from other Services, and employees of other government agencies to train and maintain their skills at remote locations.

The proposed AI device for interrogators can eventually provide "cradle-to-grave" training and maintenance of critical interviewing and language skills. The Phase IV system would have operational capabilities and could eventually feed newly gained (and verified) information into databases. It would likely decrease the requirement for language skills.



The Problem

Fort Huachuca, Arizona, is the home of the U.S. Army Intelligence Center and Fort Huachuca (hereafter referred to as "the Center") and the U.S. Army MI Corps. As one of its missions, the Center has the responsibility to train soldiers in human intelligence (HUMINT), the process by which we gather information from human sources, rather than mechanical and electromagnetic means.

How do we conduct this training? Before each interrogation or interview session, instructors must dress in appropriate attire and memorize a prepared script to role-play the "subject" of the student interrogations or interviews. During the session, the instructors are not able to guide and mentor the students through the interrogation nor can they impart their vast amount of knowledge and experience to the students. Only at the conclusion of the session do students receive meaningful comments, instruction, and mentoring from the instructors. This process does not optimize the instructors' time and talents.

When graduates from the Center reach their assigned field units, they must conduct interrogations or interviews in a foreign language. Students do graduate from the Defense Language Institute with certification that they can speak the "global" versions of their target languages and arrive at the Center where they learn the HUMINT skills and interrogation and interview procedures. However, during their studies at the Center, they do not have the opportunity to conduct an interrogation in their target languages since all interrogation training at the Center is in English. This is a matter of necessity—it is not cost-effective to maintain a team of instructors who speak the various contingency mission-area languages. They never have the opportunity to practice the new skills they are learning in their target languages.

After graduation from the Center, students must maintain not only their language skills, but also their interrogation and interview skills. This is currently a rather haphazard process. The soldiers may not have access to others

who speak their target languages; they try to maintain their language skills by listening to audio tapes at their local Education Centers. Soldiers' practice interrogation sessions (if any) are quite similar to the scripted sessions at the Center and they are usually in English.

Solution

The first and crucial step in designing any software solution is an accurate identification of the problem. As outlined above, the problems with the current methodology of training HUMINT soldiers are twofold: not being able to train in the target languages and not making effective use of the instructors' time.

The solution of this problem is to use simulation, modeling, and AI techniques to create an animated surrogate human subject, or "avatar." The student will be interrogating an animated human facade that appears on the video display. This facade will provide both verbal and nonverbal cues for the student to capture and interpret, and it will "speak" and "understand" multiple foreign languages. As the student interrogates the avatar in the target language, it will interpret the statement uttered by the student and search its memory for an appropriate response to the query. It then formulates a response based on any "character traits" or other special instructions set up by the instructor, and audibly responds to the student in the target language.

This solution frees the instructors, allowing them to mentor and to impart experience and wisdom during the interrogation session, when the student needs it the most. Further, the system could link with a simulation running anywhere in the world so that the instructors would not have to be collocated with the students, and unit costs would be lower.

This system uses current technologies in the areas of speech recognition, natural language processing, data archival, data min-

ing, and artificial voices. This system would not be stagnant, however, and would mature as technologies became available. Specifically, the system developers would integrate improvements in the areas discussed above, as well as virtual reality technologies. Future stages and the needed technologies will be discussed in more detail later in this article.

Our responsibility to train soldiers, however, does not end with the students' graduation from the Center. Indeed, our responsibility will increase since we must provide for continuous, effective, and realistic sustainment training at the units. We must not train skills at the Center that we cannot sustain in the field. This system would provide that necessary sustainment training throughout the soldiers' careers because it would facilitate maintenance of their interrogation and language skills through continual practice. The system would allow the student to sustain these skills by conducting conversations in the particular dialects needed and using both interrogation and interview skills. The maintenance of these precious skills is just as important as their acquisition and this system would provide the means to maintain these perishable skills.

Four-Phase Developmental Plan

Phase I. The Phase I system is the baseline system that establishes the foundation for future developments. It would consist of a processor with instructor and student stations. The student station is simply a video monitor and a headset with microphone. The student speaks into the microphone and hears the reply from the avatar via the system speakers. The avatar "resides" in the two-dimensional (2D) environment of the video display, replicating all visual cues such as eye movements, twitches, head and mouth movements, and so forth.

The instructor station comprises a keyboard, monitor, and mouse. The instructor begins the session by establishing the parameters—the characteristics—of the avatar. These parameters include military occupational specialty, rank "hostility factors," sex, nationality, and more. The hostility factors determine the responsiveness of the avatar and direct how much the avatar will falsify its responses to queries.

To provide you with a better understanding of the avatar, observe the data flow shown in Figure 1. The cycle begins when the student interrogator asks a question, (e.g., "How many rounds were you carrying on your tank when you were captured?"). The

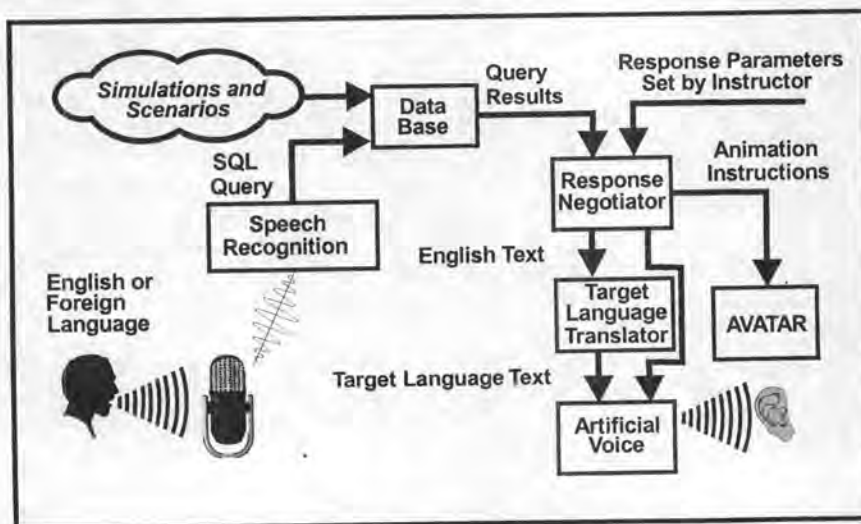

Figure 1. Data Flow Chart.

audio waveform is picked up by the microphone and transferred to a speech recognizer which translates the audio waveform into a standard query language (SQL) query format ("select value=rounds where vehicle=tank"). This query goes to an object-oriented database. This database contains all of the avatar's "knowledge" about the world. The database will always provide an accurate response to the query ("10 rounds"). However, we would not expect that a subject would willingly provide the whole truth and accurate information to an interrogator but rather would falsify the information.

We must therefore "massage" the response provided by the database within the parameters established by the instructor at the beginning of the session. This process results in a text response to the original question and a set of instructional flags that indicate the types of visual cues to provide with the verbal response. The textual answer then goes to an artificial voice element that generates the target language audio waveforms that the student hears. Simultaneously, the flags reach the animation control of the avatar to produce the visual cues that the student sees. These visual cues include both the mouth movements corresponding to the audio waveforms uttered and other visual cues such as head and eye movements. This completes one cycle. The student would then assimilate the data that he has just received and would generate another question to begin the next cycle.

The instructor can populate the database that contains the avatar's knowledge of the world in two ways. First, the instructor can use a **static database that contains a fixed set of data**. This feature is useful because the system can serve as an evaluation tool, repeatedly producing an avatar with the same fixed and known set of data. Instructors can evaluate students against a reproducible standard. The instruc-

tor would have the ability to modify the database before the start of a session in order to train specific tasks. The second population means is through **interactive play with a simulation run anywhere in the world**. By accessing the data packets being transmitted over the simulation network, the system draws off the information during the simulation and populates the fields in its database (see Figure 2). In this manner, the student could interrogate a captured enemy tank crew member that existed in the simulation, was engaged in a fire fight, and whose tank was "killed." This feature provides the ability to provide realistic training in which the interrogator may actually acquire information that would allow his commander to influence the outcome of the battle.

The first phase system would "understand" and speak English and one foreign language. A speaker-independent continuous speech system that would not require any training between users would provide the basis for the speech recognition. The instructor would have full control capabilities to establish the parameters of the session and to modify the data set stored in the "fixed" database. The system

would have a comprehensive evaluation module. This module would provide an assessment of the data that the avatar "knew" versus what the avatar verbalized during the process of the interrogation and what the avatar "implied." The instructor would then use this data to evaluate the effectiveness of the student's interrogation. The evaluation module would also have the ability to "replay" any portion of the interrogation session—with this capability, the instructor could comment on the student's performance and his ability to detect the visual cues being generated.

Phase II. The primary limitation of the Phase I system is that the avatar "lives" in a 2D flat screen. Although this system is better than what the trainers use today (nothing), we can improve it. A significant advancement would be to provide for 3D. Technology allows us to do this by using virtual reality (V/R) techniques. In Phase II, we immerse the student into a V/R environment with the avatar and allow the student to maneuver through the environment. This provides the student the ability to examine the back of the avatar, to examine its haircut, shoes, the condition of the hands under the table, and many other factors.

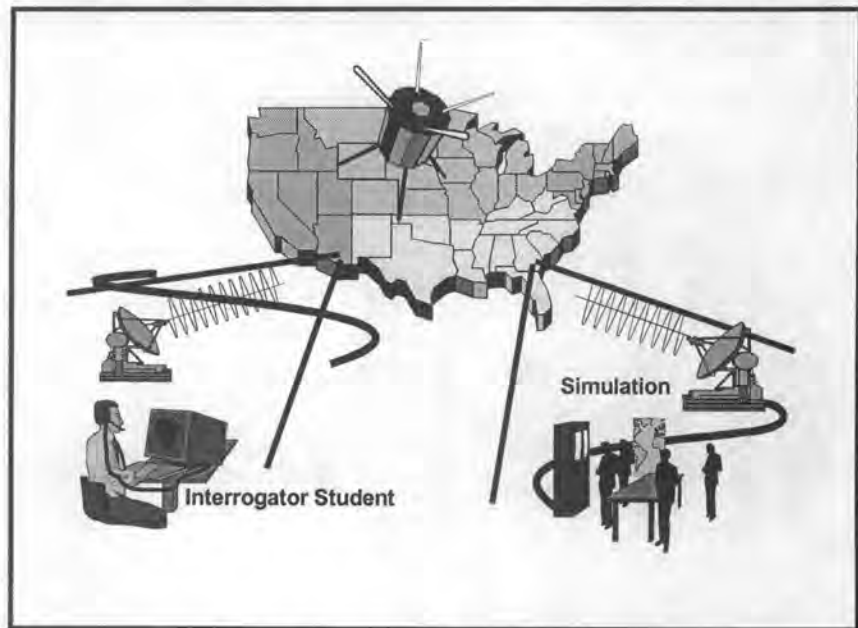

Figure 2. Integration With Simulation.

This second phase would improve on the capabilities provided in the first. The second phase would provide for multiple foreign languages, both spoken and understood. The database would continue to evolve and improve to capture esoteric-type data, such as injuries, pain, esprit de corps, and more. The animation would also continue to improve to provide better resolution and fidelity in portraying the visual cues. The visual cues would also include the avatar's "body language," that is, the hands, feet, and the position of the remainder of the body.

Phase II would also begin the transition of this device from a training tool to an operational system. This transition begins with the automated parsing of data that the avatar is receiving. AI systems would parse the output of the response negotiator module. The parsing would result in the identification of mission-critical information based on the unit commander's priority intelligence requirements and would check the perishability of the information.

Phase III. The third phase is the natural progression of the system and would reduce the required number of instructor positions. Phase III expands the V/R

capabilities to immerse multiple students who can be working the same scenario with the same avatar, the same scenario with different avatars, or different scenarios with different avatars simultaneously (see Figure 3). Simultaneously, the system would generate multiple types of avatars instead of just a single enemy prisoner of war (EPW). The system would be able to generate refugees, line crossers, several EPWs, allied scouts, village chieftains, etc. In this manner, the system would not only train HUMINT soldiers on interrogation skills, but also on their interviewing skills depending on the avatar with which they interact. When one considers the potential integration with live scenarios, the predefined relational databases, and the multiple types of avatars, the possible permutations for a simultaneous training session are nearly boundless.

Other capabilities would improve with this phase as it migrates to an operational system. The initial parsing capability introduced in Phase II would mature. Phase III would also introduce the initial automated questioning capability. AI modules would receive the parsed data and continue down a par-

ticular line of questioning, based on some specific piece of data gathered during the parsing process. For example, during an interrogation session with an EPW, the subject identifies a new enemy weapon system. The AI systems would parse that information and determine that it is critical to gather as much data as possible about the new weapon system. The AI systems would then automatically generate a new line of questioning. The system would feed questions to the students via the V/R helmet so that they could seamlessly continue the interrogation process, but at the same time capture the pertinent data.

Phase IV. The Phase IV system would transition from a dedicated training device to a "cradle-to-grave" system. The students would use the same system to gain initial training at the Center, use it at their duty stations for sustainment training, and take the same system into combat as an operational system.

This is the next logical step in the progression and evolution of this system. We would have already developed the capability of immersing multiple "humans" into a V/R to interact with subjects and with the environment. Take the same system into the combat zone and immerse a HUMINT-trained individual and a "real" EPW, refugee, line crosser, allied scout, village chieftain, etc. In this manner, we can conduct our interviews and interrogation sessions while immersed in a virtual environment. This would allow us to walk back through the chieftain's village. He could show us exactly where the enemy had buried a cache of weapons, while remaining in the relative safety of the friendly rear area.

Another significant evolutionary step in this phase is that we could use automation to overcome our language difficulties. The taxpayers currently spend large sums of money to teach companies of soldiers how to speak, understand,

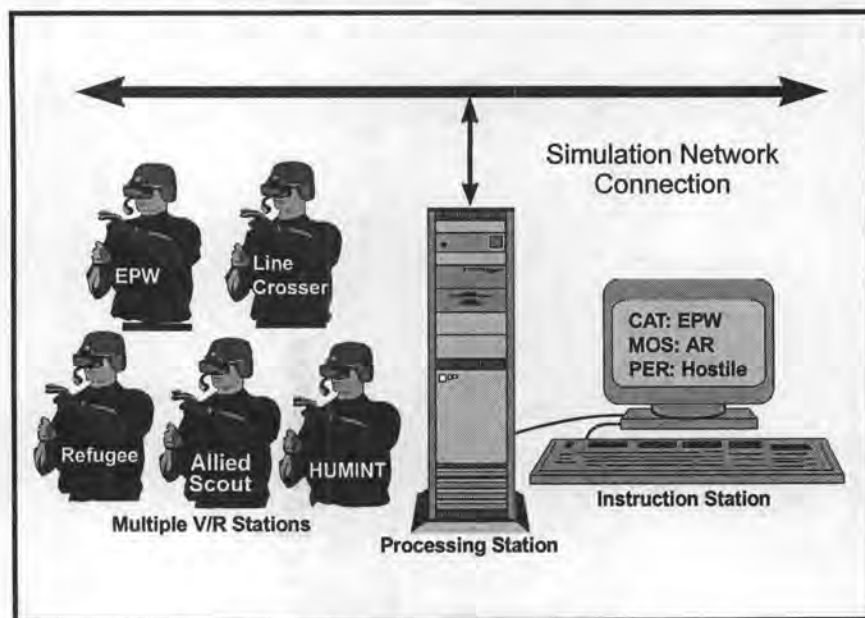

Figure 3. The 2007 Hardware Architecture.

read, and write the many foreign languages in the world. Instead, we could invest that same money into building advanced automated translators (which exist today). In this manner, we then focus on training our soldiers on their HUMINT skills, the art of eliciting information from another person who does not wish to provide us with that information. We could allow technology and automation to overcome the language barriers. As integrated into this phase, the HUMINT-trained soldier would wear his V/R helmet and the village chieftain would wear his. They would converse with each other, each hearing and speaking in his native language, with the automated system providing the translation. Simultaneously, they would be able to maneuver through the virtual environment into which they have been immersed (see Figure 4).

The final evolutionary step in this phase is the correlation of gathered and parsed data with that in national databases. As the interrogator gathers data concerning the order of battle of a particular enemy force, that data—once properly verified—automatically sends updates to nationally maintained databases. Information that is gathered about a new weapons system, location of a weapons cache, or biographical data about an enemy leader would likewise update the appropriate databases. In this manner, information received through interrogations and interviews would be available to any selected forces in near-real time (see Figure 5).

Summary

Technology and the capabilities provided by automation are growing exponentially. One of the advantages enjoyed by the United States is that we consistently take advantage of those capabilities to give us that "edge," whether it is in an economic, political, or war setting. We must continue with this estab-

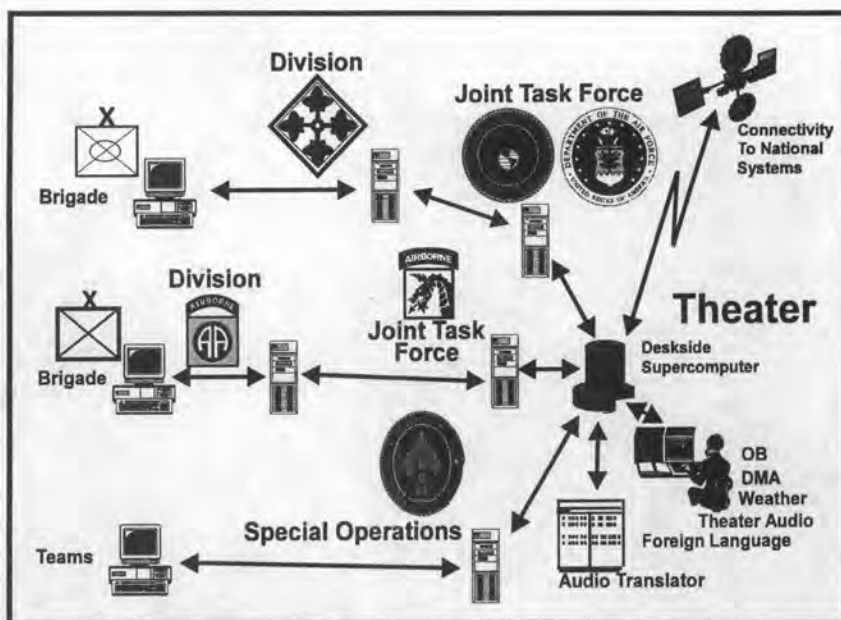

Figure 4. Theater Operations.

lished methodology and make full use of the advantages that technology is providing to us.

I have demonstrated how we can develop a singular system that can provide for our initial training needs in the Center, our sustainment training needs at posts, camps, and stations around the world, and our operational wartime needs. In the near term, the system aids initial skills development and sustainment training of both foreign language

proficiency and HUMINT techniques simultaneously. While providing more realistic training, this system would improve the accessibility of sustainment training through distance learning. In the long term, we would use our technological advantages to let automation overcome the language barriers.

This system would provide a link from remote locations through which the HUMINT soldiers—whether (Continued on page 48)

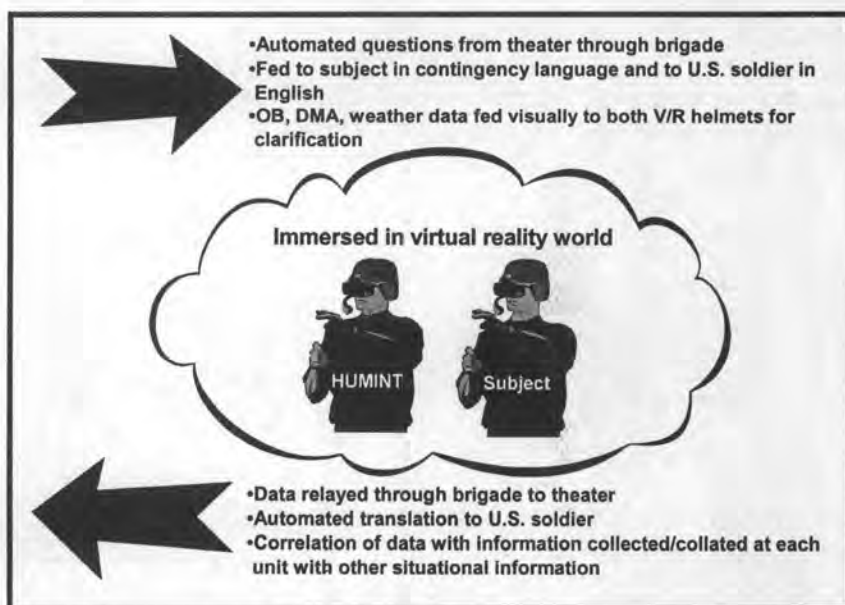

Figure 5. Virtual Reality Data from Brigade to Theater Level.

MI Officer Training at the Turn of the Century



U.S. Army photos

by Lieutenant Colonel Konrad Trautman

Training for military intelligence (MI) officers has perhaps never been tougher. It is certainly more extensive, as the U.S. Army Intelligence Center and Fort Huachuca (USAIC&FH) begins to target majors and lieutenants colonel for advanced intelligence training. Figure 1 provides an overview of the MI officer training strategy. (See the glossary on page 62-64 for expansion of the acronyms used in this article.) Here is a summary of what is new in officer training at the Intelligence Center:

- Implemented the first G2/ACE Chief Course in August 1998.
- Introduced the new MI Officer Advanced Course (MIOAC) in January 1997. We focused more instruction on brigade S2 operations and analysis of difficult-to-predict enemies. The Intelligence Center is continuously updating training on our information age technology systems. These systems include the All-Source Analysis System (ASAS), Intelligence Link (INTELINK), and the Joint Deployable Intelligence Support System (JDISS).

- Conducted an advanced intelligence training course for MI majors at the Command and General Staff College as a part of the CGSC curriculum (Course A335 Advanced Intelligence) from January through April 1998.
- Began planning for the new 10-week Functional Area (FA) 34 Strategic Intelligence Transition Course that will begin in June 1999.
- Upgraded the MI Officer Basic Course (MIOBC) in March 1998 to focus more on assistant S2, analysis and control

team (ACT) chief, and platoon leader responsibilities, and to include more information age technology systems training.

G2 and ACE Chief Course

Recognizing the need to train incoming G2s and ACE chiefs for their critical jobs, the Intelligence Center will conduct the first G2 and ACE Chief Course in August 1998. The purpose of this course is to prepare inbound or recently assigned division G2s and corps, division, and force projection brigade ACE chiefs for these important jobs.

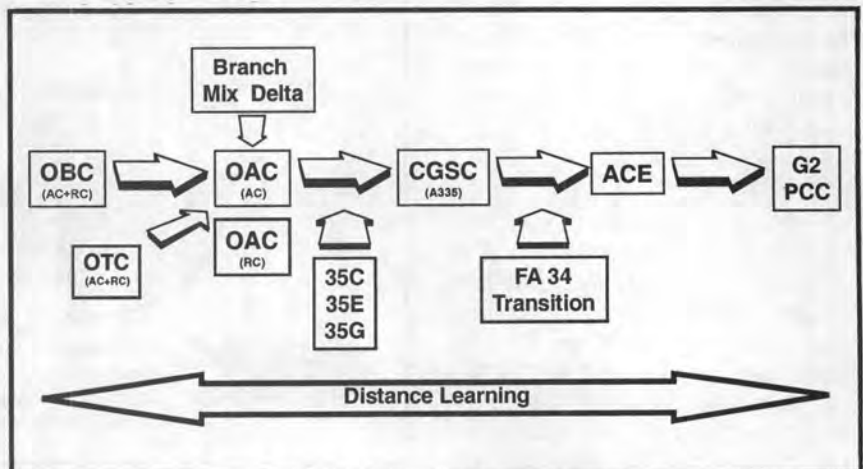

Figure 1. MI Officer Training Strategy.

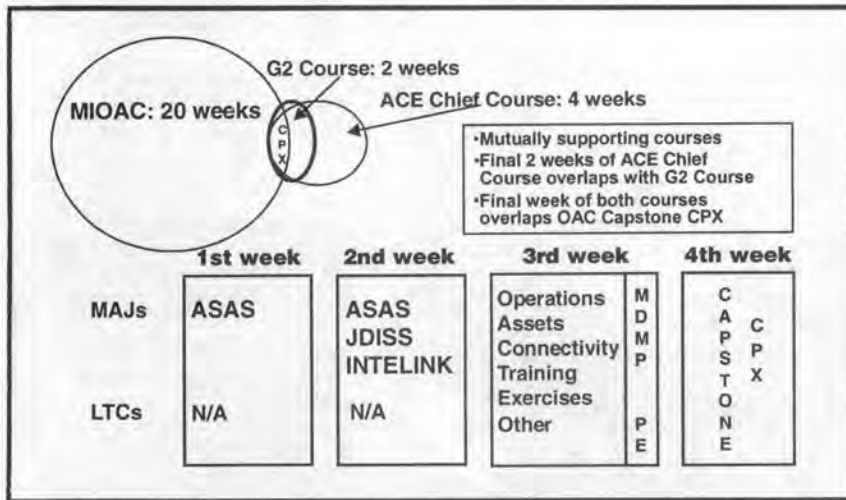

Figure 2. G2/ACE Chief Course.

This course is a watershed event because it breaks the paradigm that Fort Huachuca's institutional intelligence training stops with the MIOAC.

The G2/ACE Chief Course is actually two courses that overlap each other and also overlap the MIOAC's culmination exercise (see Figure 2). The majors have a four-week program of instruction while the lieutenant colonels have a two-week POI.

The ACE Chief Course lasts four weeks. The first and second weeks are hands-on intelligence systems training with the ASAS, JDISS, and INTELINK systems. The third week focuses on:

- G2 operations.
- Intelligence system capabilities, limitations, and concepts of employment.
- Connectivity architectures of collectors, processors, and communicators.
- G2 section training responsibilities.
- Exercise support including the Battle Command Training Program (BCTP) and the Combat Training Centers (CTCs).

The fourth week begins with a division-level military decision-making process (MDMP) exercise that leads into a simulations exercise on corps and division operations in Korea. This simulations exercise is the MIOAC culmination exercise, called the

"Capstone Exercise." The personnel attending this portion of the course will serve as ACE chiefs, supervising MI captains (OAC students) during the conduct of the exercise.

The G2 course is identical to the ACE Chief Course, except that there is no hands-on intelligence systems training. The third and fourth weeks of the course are in fact the G2 course. An essential feature of the course is the case studies training event. For this event, USAIC will bring in former G2s to discuss their lessons learned in Bosnia, Haiti, and Somalia. During the last week, the prospective G2s will play division G2s, supervising the ACE Chief majors and the ACE operator OAC students in this week-long

simulations exercise. The G2 course would also have the benefit of a senior MI colonel—a former and recent G2—to coach, teach, and mentor the G2 students throughout their course.

The first course will commence in August 1998. The ACE Chief Course will run from 3 through 28 August, and the G2 portion will be 17 through 28 August. The Intelligence Center will fund the training costs except that the student travel and per diem expenses remain a unit responsibility.

MIOAC

The purpose of the MI Officer Advanced Course is to train MI officers to be proficient battalion and brigade S2s, ACE battle captains, and company commanders. Figure 3 shows the MIOAC course flow, and Figure 4 depicts the critical skills and knowledge sets associated with each of the MIOAC graduates' three target assignments. Approximately 73 percent of MIOAC graduates receive direct assignments to echelons corps and below (ECB) units.

The MIOAC is a very demanding and tough course. Recycle rates of nearly 10 percent have been the norm for the last nine months—since the fiscal year (FY) 1997 "new" OAC course hit full stride. The students' average week includes 40 hours of academic instruction with heavy

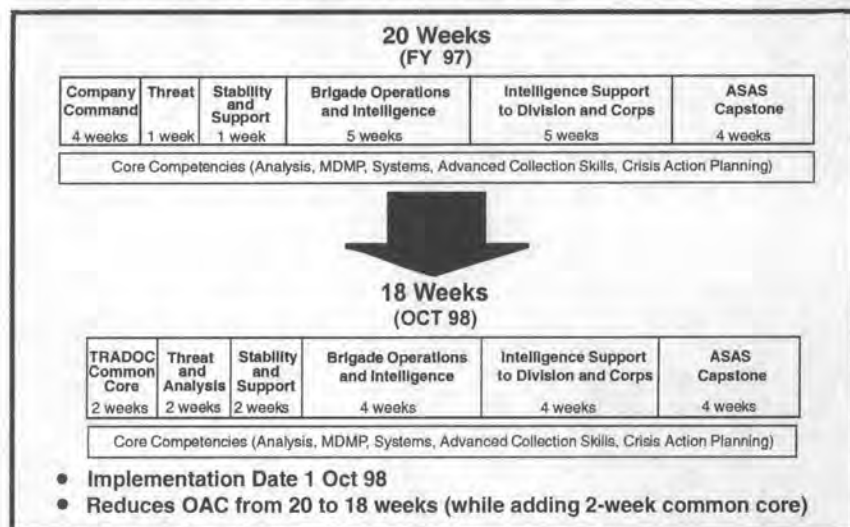

Figure 3. Restructured OAC.

Battalion & Brigade S2	ACE Battle Captain	Company Commander
<ul style="list-style-type: none"> • Conduct IPB. • Process and analyze intelligence and combat information. • Determine and develop enemy courses of action. • Produce situation templates for operations at Bn/Bde level. • Perform predictive analysis. • Determine/recommend PIR. • Execute collection management at Bde/Bn level (recon/counterrecon). • Develop a decision support template during wargaming ICW staff. • Understand the targeting process. • Understand and develop the HPT/AGM/TSS during wargaming. • Produce and brief an S2 mission analysis briefing. • Produce and brief an intelligence estimate. • Understand the MDMP and the S2's contribution to the MDMP at Bde/Bn level. 	<ul style="list-style-type: none"> • Plan and execute collection management. • Understand capabilities of corps and division intelligence collection systems. • Produce division intelligence annex. • Supervise and operate automated intelligence processing operations (ASAS). • Provide intelligence support to force protection operations. • Conduct crisis action planning. • Operate INTELINK/JDISS. • Understand joint and national intelligence capabilities. • Provide intelligence support to planning and execution of support and stability operations. • Understand national and theater-level all-source products. • Plan tactical tailoring for split-based IEW operations. • Provide intelligence support to targeting. 	<ul style="list-style-type: none"> • Plan and execute IEW operations in support of Bde operations. • Understand capabilities of IEW DS and GS company assets. • Produce and brief a company OPORD. • Produce connectivity diagrams for all IEW assets within divisional DS and GS companies. • Establish a unit intelligence training program. • Understand tactical CI operations. • Understand supply/maintenance operations at company level. • Achieve proficiency in all captains' career course common core requirements. <div data-bbox="1094 655 1442 795" style="border: 1px solid black; padding: 5px; margin-top: 10px;"> <p>Note: Knowledge = "understand" Skills = "produce, operate, determine, participate, install, employ, conduct, execute"</p> </div>

Figure 4. MIOAC Mission-Focused Critical Skills and Knowledge.

emphasis on practical exercises, and 20 hours of homework. Some blocks, most notably the Brigade Operations and Intelligence (BO&I) Block, far exceed this average, with students typically working through their weekends in "tactical operations center (TOC) bays" to produce mission analysis, intelligence estimate, and reconnaissance and surveillance (R&S) briefings and graphic products. The title photograph for this article shows MIOAC students working in a TOC bay. This is certainly no country club curriculum.

Starting on 1 October 1998, all Branch OACs will fully integrate with the Combined Arms and Services Staff School (CAS³) as part of the Army's new captains' career courses. All OACs will reduce to an 18-week curriculum that begins with a 2-week Training and Doctrine Command (TRADOC) common core curriculum. The remaining 16 weeks of the OAC are Branch-specific training. Upon graduation, the captains immediately attend CAS³ before further assignment to their gaining units. We have thoroughly reviewed all of the MIOAC POIs to avoid any redundancies with the CAS³.

This has minimal impacts on the current MIOAC. The initial phase of the course already focuses on these TRADOC common core subjects. This phase also includes MI-specific training in preparation for company command. The next major block is BO&I. This demanding block trains MI officers to become proficient S2s. For 21 training days, students will be immersed in a detailed MDMP to support a brigade's deployment to, and employment in, a stability operation that includes a potential for a conventional invasion from a neighboring country. This block will culminate with a one-day situational training exercise (STX) where the students will "fight" the enemy while in a conventional defense. Via the Warlord Notebook system, instructors will evaluate them on their abilities to perform dynamic R&S operations. The students are required to modify their existing R&S plans to correctly discern the enemy's actual course of action (COA).

The students next move into the Intelligence Support to Division and Corps (ISDC) Block. During this phase, students will conduct another MDMP section centered on a division's deploy-

ment and operations in the Republic of Korea. The students will learn the capabilities, limitations, and concepts of employment of the division, corps, joint, and national intelligence systems that they employ throughout this block. They also study intelligence architectures and produce connectivity diagrams for all collectors, processors, and communicators that they use in their multiple practical exercises (PEs).

Although we embedded intelligence systems training throughout the course, at the conclusion of the ISDC phase, the students receive dedicated, focused training on the ASAS. Earlier in the course, they received training on INTELINK and JDISS: training that they will now put to use in a 36-hour "crisis action PE." During this PE, each squad operates as a different division ACE that researches, prepares, and briefs a G2-level mission analysis product for an actual real-world contingency operation. Students will use the INTELINK to access the Military Integrated Database (MIDB), 5D IMINT (imagery intelligence) database, and other databases and homepages that they will use to produce the mission analysis briefing.

The MIOAC culminates with its "Capstone Exercise," a Joint Conflict Model (JCM) and Tactical Simulations (TACSIM) exercise that employs one corps and two divisional ACEs. The students play the essential roles in the ACEs and act as G2 and G3 operations and plans officers. This part of the MIOAC is the execution phase of the operations plans (OPLANS) that the students produced during the ISDC Block. In the Capstone Exercise, the students now fight a defensive Korea-based scenario. Instructors evaluate the students on their abilities to discern the enemy's actual COA, to proactively and effectively plan and execute division and corps collection operations, and to provide intelligence support to deep strike targeting.

In accordance with the new **FM 100-5, Operations**, stability operations and support operations are integrated throughout the MIOAC. Classroom instruction occurs early in the course; then the students conduct numerous exercises at brigade and division levels throughout the course involving these types of operations. The crisis action PE described above is an example of integrating an actual stability-and-support-operations environment into systems training.

The MIOAC graduates are fully qualified for their new duties. As was mentioned earlier, nearly three-fourths of the graduates will serve as battalion or brigade S2s, ACE battle captains, or company commanders.

CGSC Advanced Intelligence Training

In January 1998, the Intelligence Center began teaching advanced intelligence skills to MI majors attending the Command and General Staff College at Fort Leavenworth, Kansas. The purpose of the 40-hour "A335 Advanced Intelligence" course in the CGSC curriculum is to train the students on ACE and ASAS operations in preparation both for their future military assignments

and for the CGSC Prairie Warrior Exercises conducted each April. This training covers ACE operations, all-source (AS) and single-source (SS) functions, database management, collection management, systems administration, and the ASAS-Remote Workstation (ASAS-RWS) operations.

The Intelligence Center also conducts two-day tactical MI refresher training. This session occurs at Fort Leavenworth before the start of the CGSC class in August each year.

Functional Area 34 Strategic Intelligence Transition Course

The Intelligence Center has begun planning this new Strategic Intelligence Transition Course. FA 34 is part of the Information Operations Career Field under the new Officer Personnel Management System (OPMS) XXI. FA 34 strategic intelligence officers will first attend this transition course at Fort Huachuca and then the Joint Military Intelligence College (JMIC) in Washington, D.C., for the remainder of their qualification training. The Intelligence Center plans to execute this 10-week-long course in June 1999 to prepare Army majors—most of whom may not be MI Branch officers—for success at their Post-Graduate Intelligence Program (PGIP) follow-on training at the JMIC and as valued members of the MI team.

Figure 5 shows the FA 34 Transition Course overview. The bulk of the course focuses on intelli-

gence operations at division and corps, so that the future strategic intelligence officers are familiar with the capabilities and limitations that these Army units bring to joint task force (JTF) operations. Throughout the course, the students will study the embedded competencies of analysis, research, writing and presentation skills, and intelligence systems (JDISS, INTELINK, Open-Source Intelligence System (OSIS), Army Global Command and Control System (AGCCS), 5D IMINT database, and Joint Collection Management Tools (JCMT) software training).

MIOBC

The purpose of the MIOBC is to train MI lieutenants as proficient assistant S2s, analysis and control team (ACT) chiefs, and platoon leaders. Eighty percent of MIOBC graduates will serve in ECB units in one of these target assignments. Similar to the OAC, the OBC course also has a critical skills and knowledge set focused toward these probable assignments. The first revised MIOBC began in March 1998 (see Figure 6). Major activity upgrades in the course include:

- Increased emphasis on how U.S. maneuver battalions and brigades fight. Nearly ten days of this training—occurring early in the course and taught by combat arms officers—teaches the MI officers to better analyze enemy and U.S. COAs during future wargames.

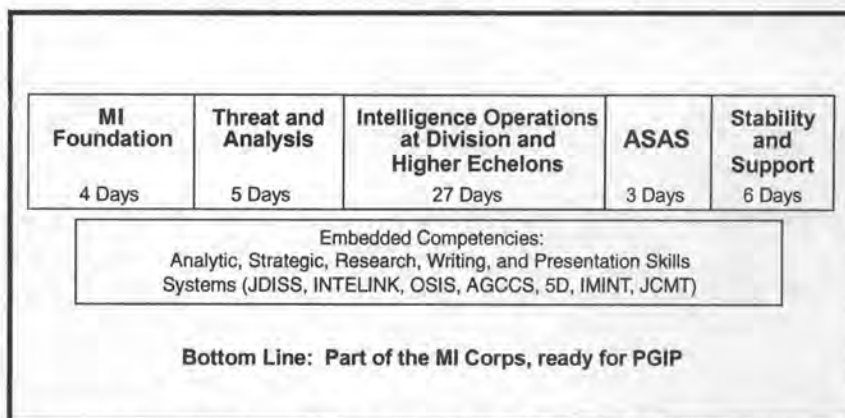

Figure 5. FA 34 Strategic Intelligence Transition Course Flow.

- Increased training in stability and support operations, in line with the new **FM 100-5**.
- Addition of a one-week training block where lieutenants receive job-specific assignment-focused training for either ECB or echelons above corps (EAC) assignments.
- Increased training on information age technology systems, specifically JDISS and ASAS-RWS. Students will learn traditional S2 skills without an RWS, and then gradually integrate RWS use in subsequent iterations of the MDMP cycles, before their culmination field training exercise that uses the RWS non-stop for five days.

The MIOBC Brigade All-Source Intelligence Exercise (BASIX) is the culmination exercise during which the students operate a brigade TOC, three task force TOCs, and one ACT collocated with the brigade TOC. The lieutenants practice their new MI skills and knowledge in continuous operations.

Other Officer Training

There are many other aspects of MI officer training that I do



The OBC teaches critical skills to new MI officers, training them for their next assignments.

U.S. Army Photo

weeks and focus more specifically on preparation for the OAC. All OTC graduates immediately attend the OAC.

Area of Concentration (AOC) Specialty Courses. The 35C (IMINT), 35E (Counterintelligence), and 35G (Signals Intelligence) AOC specialty training courses are currently undergoing complete revision, similar to the recent OAC and OBC upgrades. These new AOC courses will commence in FY99.

Web Site. We urge all MI officers, particularly those preparing to attend the MIOAC, to see our web site [<http://huachuca-usaic.army.mil/SCHOOL/111MI/326TH>] to review the OAC POI and lesson plans. If you know that you have weaknesses in a particular area, you can now access and review the actual lesson plans for the MIOAC in preparation

for the course.

The 304th MI Battalion's web site also contains many "how to" products for brigade and battalion S2s. "School solution" mission analysis briefings, intelligence estimates, R&S plans, collection management plans, and intelligence synchronization matrices exist on our web site. These are

not cover in this article. Let me briefly summarize several of them.

Officer Transition Course. The OTC continues to prepare both the Branch-detailed and Branch-transferred officers for success in the MIOAC as well as the MI Corps. This course will condense from seven to four

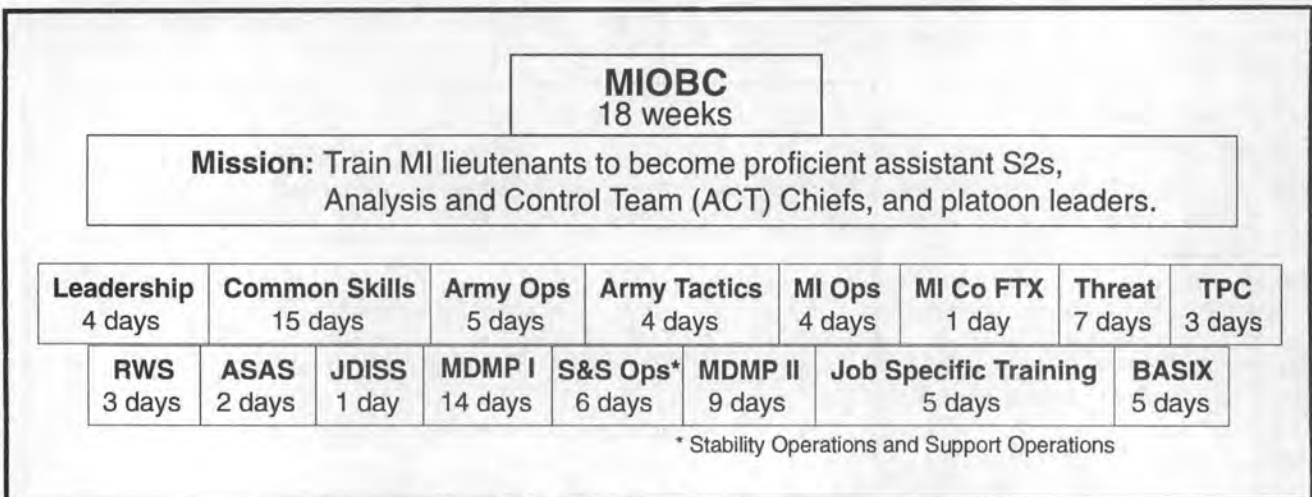

Figure 6. MI Officer Basic Course Flow.

Officer Training Photos



valuable tools from which to cut-and-paste unit-specific products.

Final Thoughts

Most importantly, the center of gravity for all of the officer training described above is the quality of our instructor force. Our instructors comprise a combination of MI and combat arms officers, non-commissioned officers (NCOs), Department of the Army civilians, and contractor personnel. These instructors train, coach, and mentor our student officers to become proficient in their trades. We do not accept all who seek this duty, and we frequently endure a shortage

of instructors rather than accept the next available officer as an instructor. If you are a branch-qualified MI captain with strong S2 experience, and you are interested in immersing yourself in our MI trade, contact the 304th MI Battalion Executive Officer (XO) at hoehner@huachuca-emh1.army.mil for more information.

Lieutenant Colonel Trautman commands 304th MI Battalion (Advanced Intelligence Training Battalion), Continuous Learning Directorate, U.S. Army Intelligence Center and Fort Huachuca. He recently served as the Deputy G2, 25th Infantry Division (Light) and XO, 125th MI Battalion (CEWI); he deployed and served with the Division during Operation UPHOLD DEMOCRACY in Haiti. LTC Trautman

is a Joint Specialty Officer, having served in both combined and joint intelligence assignments with the Republic of Korea-U.S. Combined Forces Command and U.S. Forces Korea. He has experience as an S2, having held that position with the 3d Squadron (Reconnaissance), 4th Cavalry, 25th Division (Light), and the 4th Special Operations Command. LTC Trautman has commanded a Special Forces "A" Detachment and a SIGINT Company in the 703d MI Brigade. He has a bachelor of arts degree in International Affairs from Pennsylvania State University (where he was a Distinguished Military Graduate) and a Master of Military Arts and Science degree from the U.S. Army CGSC. Interested readers can contact him via E-mail at trautmank@huachuca-emh1.army.mil or by telephone at (520) 533-6522 or DSN 821-6522.

Sharpening the Edges: Technical Training in the ANCOC

by First Sergeant
Bradford R. Jenkins

As today's Army changes, so must the concept of training for senior noncommissioned officers (NCOs). The primary focus of the Advanced Noncommissioned Officer Course (ANCOC) has been leadership. The major change occurring in ANCOC is the inclusion of prerequisite and technical training for each MOS and the replacement of stagnant training with dynamic, performance-oriented training.

Leadership is (and will continue to be) the cornerstone of the Noncommissioned Officer Education System (NCOES). ANCOC is developing a training strategy in accordance with the **Intelligence Training XXI: Ready Now—1997 Action Plan** that will—

produce an NCO who is able to perform across the spectrum of Army XXI missions and operations—technically, tactically, and as a leader.¹

ANCOC is thematic and builds upon skills learned. The course technical training improves the individuals' skills in their disciplines. The scenario-driven end-of-course situational training exercise complies with Objective 1.4 of the **Action Plan**.² The ANCOC will be a four-phase course.

ANCOC Training Phases

Phase I: Prerequisite Training. Prerequisite training will be mandatory for every military intelligence NCO. MI soldiers will receive self-development and distance learning packages (DLPs) and career maps, optimally upon graduation from BNCOC. These packages will range from 80- to 300-hours long, depending on the particular MOS. For example, 98Cs (Signals Intelligence (SIGINT) Analysts) would require 84 hours of National Cryptologic School courses while 98Gs (Voice Interceptors) would require approximately 280 hours of various courses from the NCS and other or-

ganizations prior to attendance at ANCOC. The DLPs should be available in the first quarter fiscal year 2000 (1Q FY00).

Once the DLPs are available, all NCOs will have ample time to complete them before selection for and attendance at ANCOC. A 100-question pre-test will be administered prior to the start of the resident ANCOC training. Twenty-five of the questions will cover the Phase I DLP to validate the quality of the DLP and the NCOs' comprehension of it, as well as the retainability of the Phase I training. The remaining 75 questions will include a 40-level performance-based evaluation and written questions.

Phase II: Common Leader Training. CLT (also known as Common Core) comprises training mandated by U.S. Army Training and Doctrine Command (TRADOC) and the U.S. Army Sergeants Major Academy (USASMA). It will teach platoon-level tasks to staff sergeants-promotable and

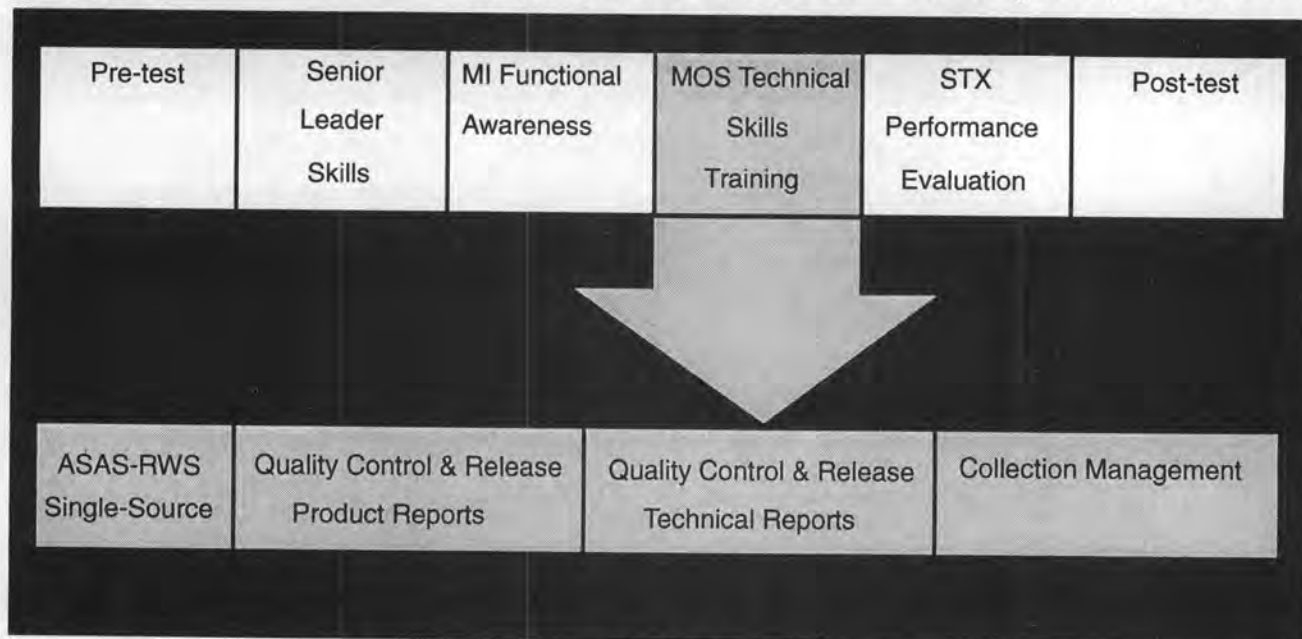

Figure 1. Sample ANCOC Course Flow.

sergeants first class Army-wide. The USASMA and the various proponents have revised many of the tasks in this phase of training. We anticipate that the new CLT implementation date for the MI ANCOC classes will be 2Q FY99.

Phase III: Military Intelligence Common Core. This phase is similar to CLT but the U.S. Army Intelligence Center drives the content. It provides a broad perspective of the senior MI NCOs' duties and responsibilities common throughout the intelligence field in senior, master, and NCO in charge positions. During this phase, we will produce a well-rounded MI NCO able to operate in a multidiscipline environment.

Phase IV: Military Intelligence Technical Skills Training/Situational Training Exercise (STX). This is a 16-day block of instruction designed to develop technically proficient NCOs capable of supporting the commander's battle plan at division and higher echelons. It provides advanced technical training that improves individual soldiers' skills in support of missions that they might execute on a contingency basis or in an asymmetric³ environment.

The technical skills training block culminates with an STX that replicates a number of intelligence-related cells:

- National.
- Regional SIGINT Operations Center (RSOC).
- Enemy prisoner of war (EPW) interrogation.
- Deployable intelligence support element (DISE).
- Division tactical operations center (TOC).
- Brigade analysis and control team (ACT).
- All-Source Analysis System (ASAS).

The STX will evaluate the individual's proficiency in accessing information systems and databases at levels ranging from tactical to multinational.

Modular Course Design

The technical training content and subsequent implementation dates of each MI MOS-specific ANCOC depend on the continuing MOS mission analysis and training strategy development process, nicknamed "cradle-to-grave." This process works best when seasoned NCOs with varied assignment backgrounds and experience

provide the input. The developers designed the training to be thematic and as realistic as possible with a "ramp-up" approach; they intended it to eliminate redundancy of material taught in the Primary Leadership Development Course (PLDC) and BNCOC. The course is currently modular in concept to adapt more easily to changes directed by the USASMA and the cradle-to-grave process.

Endnote

1. USAIC&FH, *Intelligence Training XXI: Ready Now—1997 Action Plan*, undated.
2. *Ibid*, page 29. Objective 1.4: Improve mission-based training at the Intelligence School by developing and implementing a structured family of exercises rooted in Army XXI doctrine, organization, and expected scenarios.
3. Nonconventional warfare.

First Sergeant Jenkins is the ANCOC 1SG, NCO Academy, Directorate of Continuous Learning, at Fort Huachuca, Arizona. He has been an integral part of the cradle-to-grave process for all MOSs and is currently developing surveys for the ANCOC technical training requirements. His former assignments include Hunter Army Air Field, Georgia; Heilbronn, Katterbach, and Mainz-Finthen, Germany; Fort Devens, Massachusetts; and Fort Lewis, Washington. He has earned an associates degree in applied science and continues to work toward his bachelor of arts degree in business administration. Readers can reach 1SG Jenkins via E-mail at jenkinsb@huachuca-emh1.army.mil or telephonically at (520) 533-4217 and DSN 821-4217.

CFSO Course

The Counterintelligence Force Protection Source Operations (CFSO) Course is a five-week school for functional-level counterintelligence (35E, 351B, and 97B) and interrogation (351E and 97E) personnel. Designed for soldiers that are, or will be, assigned to CFSO positions in both echelons above corps and echelons corps and below, the CFSO Course is sponsored by the U.S. Army Training and Doctrine Command and conducted by the U.S. Army Intelligence Center and Fort Huachuca. The core subjects are Mission Planning and Analysis, Operational Cycle, Operational Security Techniques, Intelligence Contingency Funds (ICF), Counterintelligence Human Intelligence (HUMINT) Automated Tool Set (CHATS) Familiarization, and CFSO Reporting.

Soldiers interested in attending the CFSO Course should contact their local School's noncommissioned officers. If you have additional questions regarding the CFSO Course, contact the CFSO staff at (520) 533-1294, DSN 821-1294, or oconnell@huachuca-emh1.army.mil. You can also reach us through our Internet website at <http://huachuca-usaic.army.mil/school/111MI/326th/mioac/cfs0/main.html>.

The New 98C BNCOC Training Strategy

by First Sergeant
Timothy P. Carroll, Jr.

The Noncommissioned Officer Academy (NCOA) at Fort Huachuca is updating the Basic Noncommissioned Officer Courses (BNCOCs) taught for several of the military occupational specialties (MOSs). This process is part of the "cradle-to-grave" examination of the U.S. Army Intelligence Center and Fort Huachuca (USAIC&FH) training strategies from initial entry to retirement. The 98C Signals Intelligence (SIGINT) Analyst Working Group was one of the first cradle-to-grave groups convened, and it serves as a good example for those that will follow.

General Approach

A significant finding of the 98C Analyst Working Group was that the 98C BNCOC is not meeting the consumer's needs. The course, like other BNCOCs, is not teaching the NCOs to adapt to the non-doctrinal threats that the U.S. Army now faces throughout the world. The Deputy Commanding General, USAIC&FH, approved a 98C training strategy that will produce an MI professional at the staff sergeant level who is a master analyst and a journeyman reporter, collection manager, and tool operator. The intent is to train analysts who can adapt to a non-doctrinal threat (defined as one with no standing operating procedures)—analysts who can conduct pattern analysis, build a set of warning indicators, and ably present their findings. In the case of the 98C BNCOC, we will both achieve this goal and reduce the length of the course by the implementation date of March 1999.

The Group developed the training strategy with the view that we must think beyond normal training templates to achieve our intent. The focus will be more on logic, critical thinking, and skills application than on retention of facts. The students will accomplish the course individually, although there will be instructor and peer tutoring.

We must revise the evaluation process to measure the application of skills rather than the ability to recall facts, conduct research, or to solve simple problems. We believe that the real key to making this a mature and profitable process lies in the evaluation strategy. There will be two formal evaluations. Throughout the BNCOC course, the students will maintain a "target folder," keeping track of all work performed. The instructor will advise the class to keep all their notes so that they may demonstrate the work they did and the folder will include supporting materials showing how or why they made certain analytical decisions. The most significant item in the folder will be the reports. They represent the distillation of the students' collection management (CM), analysis, and tools application. The instructor will scrutinize the folder contents at the formal evaluation points. We are presently discussing other evaluation strategies.

We will also use after action reviews (AARs) as often as possible. We are including two formal AARs and the instructors will conduct impromptu AARs when they observe students at an impasse in a particular area of instruction.

As is mentioned in Sergeant First Class Michael Taylor's article in this issue of *MIPB*, the premises for the 98C BNCOC training strategy are:

- Assume that the students possess 10- and 20-level skills and knowledge. The BNCOC's mandate is to train 30-level skills. We are confident that students will recover their 10- and 20-level skills and knowledge through practice and peer tutoring.
- Teach skills through a "knowledge, practice, apply" approach. In this approach, the instructors present knowledge followed by a practical exercise. Once the instructor is confident that the class grasps the knowledge, the students will apply the newly learned skill against a threat scenario used throughout the course.
- Evaluate the students' applied skills. We are committed to going beyond simple knowledge retention and developing the skills required to work in any environment.
- Challenge the students to think via a non-doctrinal threat scenario. This is the heart of our training strategy: they will apply their new knowledge to the scenario as they learn it. Our goal in the 98C BNCOC is to develop a scenario with complicated traffic patterns requiring real analysis and application of skills. We intend to build a problem slightly beyond the students' abilities—one that does not constrain them to a single "school solution."

98C BNCOC Course Flow

After the 17 days of Army Common Leader Training, the 98C students start their technical (SIGINT analysis) training. The threat scenario is in two parts: 46 days at echelons above corps (EAC) and 17 days at echelons corps and below (ECB). The difference between the time allotted to EAC and ECB reflects the

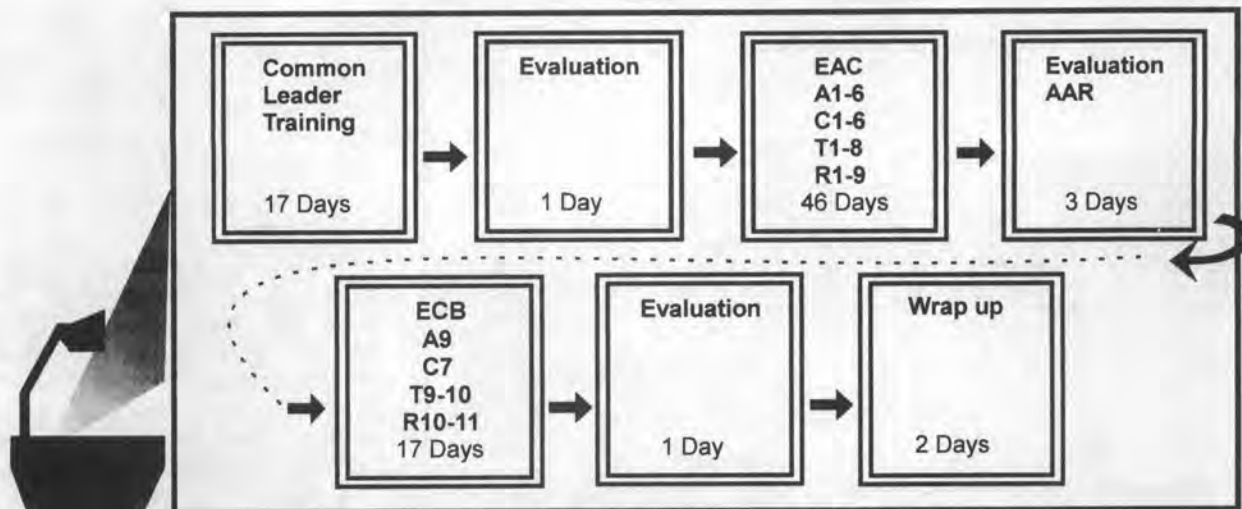

Figure 1. 98C BNCOC Course Flow.

distribution of MOS 98C throughout the force. The EAC phase runs from academic day 21 to day 61; then there is a day of evaluation and one for the AAR. The ECB portion is from day 64 through day 77, followed by one day of evaluation, one for the AAR, and a day for the course wrap-up and graduation.

Figure 1 depicts a sample 98C BNCOC course flow (see the glossary on page 62 through 64 for expansion of the acronyms). The technical training starts with three days for a pre-test, discussion covering the whole intelligence system (see Figure 2), and an introduction to the threat scenario. This is the scenario that students will use to apply what they learn and to document their understanding.

Each alphanumeric core competency shown in Figure 3 represents a lesson in knowledge, practice, or application. The EAC

and ECB blocks on Figure 1 show when the instructors teach the various competencies. In the 98C course flow, the students will have one to three days of training in several tasks followed by one or two days devoted to productive activities applying the knowledge learned against the threat scenario. After the final formal instruction and practice sessions in the EAC and ECB blocks, students will have several days to prepare for the block evaluation. The sequence and timing of events is still under development.

The first knowledge-practice-apply training event in the EAC phase will be T1 (tools). Soldiers will learn the National Security Agency (NSA) LOOKING GLASS software applications.

The second training event, C1, is a critical event. We will present a CM lesson that the students will then apply to get their first load of message traffic. Stu-

dents who do well will get the full initial traffic load, while those whose performance is mediocre or poor will get a medium or light traffic load. The students who do poorly will obviously exhaust their messages before the student who earned the full traffic load; they will have to execute the CM process again to obtain the remainder of the traffic. In this way, we can train them to improve on their weaknesses. The students will continue to employ various CM methods as they progress through the course. The instructors will deliver message traffic the way it arrives in units—daily, with three days' accumulation on Mondays. The class will conduct research with the tools via various CM and data mining methods.

Similar training events will occur in the analysis and reporting competencies, with the students conducting analysis and creating reports as they make discov-

<p>EAC K- Intelligence Community Overview</p> <ul style="list-style-type: none"> ▪ Organizations ▪ National Intelligence Requirements/SIGINT Requirements System ▪ SIGINT sites, functions and capabilities, assets, and mission (national and Service-specific) 	<p>EAC K- Communications Methods</p> <ul style="list-style-type: none"> ▪ Signals/comms technology (cellular phone, freq hoppers, spread spectrum, multi-channel/multiplex, COMSAT, PROFORMA, computer-to-computer, data, etc.) ▪ Define purpose of various signals/comms technologies ▪ Recognize signals/comms capabilities and limitations 	<p>ECB K- Strategic Systems</p> <ul style="list-style-type: none"> ▪ TENCAP Systems, CTT, JWICS, JDISS ▪ MI Bde, MI Bn, and the ACE and ASAS
--	---	---

Figure 2. Overview of Intelligence Organization, Methods, and Systems.

Knowledge/Skills Areas

Overview and Intro to 98C BNCOC

- C1- Prepare and respond to RFI
- C2- Implement tasking
- C3- Prepare Tasking ITDB CONMSG
- C4- SIGINT Amps (Apply USSIDs 9 and 18)
- C5- Evaluate tasking: prepare position effectiveness report, prepare collection management messages
- C6- Prepare resource status report
- C7- Division MI Bn and corps MI Bde collection management

Tools

- T1- Pinsetter
- T2- Oilstock
- T3- Quicksilver
- T4- Tinman
- T5- COINS
- T6- F3S
- T7- Anchory
- T8- ASAS-SSW
- T9- Joint Collection Management Tools (JCMT)

Analysis

- A1- Callsigns, frequencies, schedules, authentication
- A2- Message externals: preambles, postambles, discriminants, indicators, addresses, serial numbers
- A3- Procedure keys and charts using Latin Squares
- A4- Reconstruct multi-model/media networks
- A5- Correlate comms structures/networks to order-of-battle
- A6- Identify high-value C² Targets
- A7- Templating
- A8- Results briefing
- A9- EPB

Reporting

- R1- Klieglights and CRITIC
- R2- Product
- R3- TEXIN
- R4- ITN and TSR
- R5- Finished SIGINT reporting
- R6- SIGINT summary
- R7- Noncodeword reporting
- R8- Tearline and collateral-level reporting
- R9- Evaluate data and information reports; incorporate into other reports
- R10- TACREP and TACELINT
- R11- COMINT Graphic Overlay

Note: See the glossary on pages 62-64 for expansion of these acronyms.

Figure 3. Knowledge and Skills Taught at 98C BNCOC.

eries from the traffic. As the blocks progress, the content of the student course folders will expand, documenting their achievements.

Days 62 and 78 are formal evaluation events focused on the contents of the student folder including a checklist of the minimum requirements students must complete. The instructor will evaluate all CM, analysis,

and reporting skills through the target folder. Days 63 and 79 are the comprehensive AARs. The intent of these events is to ensure that all of the soldiers learned the required lessons.

On day 63, the students receive "alert orders" to deploy to an ECB unit. Obviously, the focus during the ECB portion of the course is narrower. They carry their target folders forward from

the EAC part of the course. Our intention for doing this is to demonstrate to the students both how important EAC intelligence is to the combat commander, and that the quality of the EAC intelligence will significantly impact on the ECB mission.

On day 64 (the first day of the ECB block), the soldiers will learn MI battalion operations and the required tools including the All-Source Analysis System-Single Source (ASAS-SS) workstation. Students will progress through this phase learning ECB CM, analysis, and reporting methods, as well as more tools.

Conclusion

The training development challenges incumbent on us now are to develop the scenario with the proper timing, sequence, message traffic, and a sound evaluation strategy. We are confident we can accomplish this goal and implement this new training strategy by the March 1999 98C BNCOC class.

First Sergeant Tim Carroll oversees the 98C BNCOC course. His most recent assignments included 1SG Headquarters and Headquarters Operations Company and 1SG Analysis and Control Element at the 104th Military Intelligence Battalion at Fort Hood, Texas. 1SG Carroll has a bachelor of science degree in Computer Science from the University of Maryland. Readers can contact him via E-mail at carrollt@huachuca-emh1.army.mil or by telephone at (520) 533-1174 or DSN 821-1174.

MI Corps Hall of Fame Nominations

The Headquarters, U.S. Army Garrison, Fort Huachuca, Arizona, accepts nominations throughout the year for the MI Hall of Fame. Anyone can nominate an individual for induction into the MI Corps Hall of Fame. Commissioned officers, warrant officers, enlisted soldiers, or civilians who have served in a U.S. Army intelligence unit or in an intelligence position with the U.S. Army are eligible for nomination.

A nominee must have made a significant contribution to MI which reflects favorably on the MI Corps. In certain isolated instances (particularly in the case of junior soldiers), the nomination may be based on heroic actions rather than other documented contributions.

Nominees cannot be employed by the U.S. Government in any capacity at the time of their nomination. Individuals cannot be self-nominated. An annual Hall of Fame Board convenes to review nominations and make recommendations to the Chief of MI, who is the final approving authority for inductions into the Hall of Fame.

The OCMI provides information on nomination procedures. If you wish to nominate someone, contact Mr. Jim Chambers, U.S. Army Intelligence Center and Fort Huachuca, ATTN: ATZS-CDR (Hall of Fame), Fort Huachuca, AZ 85613-6000; call (520) 533-1178 or DSN 821-1178; or send an E-mail to chambersj@huachuca-emh1.army.mil.



96B Training Strategy

by Lieutenant Colonel
Timothy J. Quinn

Selected senior enlisted intelligence analysts, training and evaluation civilian specialists, a senior 350B All-Source Intelligence Technician Warrant Officer, and other personnel from the U.S. Army Intelligence Center (USAIC) assembled in the summer of 1997. Their purpose was to improve the training of 96B Intelligence Analysts throughout their careers—a process of training strategy development.

Our intent was to look vertically at the military occupational specialty (MOS). We wanted to ensure that we were teaching the right skill and knowledge (S/K) set at each level, specifically those S/Ks that analyst soldiers would need in their most likely assignments during the next five years. With our statement of the S/Ks as the cornerstone, we developed the training strategy skill levels for 96B10, 96B20, 96B30 Basic

Noncommissioned Officer Course (BNCOC), and 96B40 Advanced Noncommissioned Officer Course (ANCOC), as well as the Reserve Component (RC) 96Bs. This article captures the important points of that training strategy.

Mission Analysis

The 96B Intelligence Analysts of the future will function in an Army with more technology than ever before in both collection and analysis. The 96B analyst will “see” the battlefield faster, with greater resolution, and from a multitude of sensors fed into lower echelons. The analyst must be able to interface with the evolving technology tools to effectively answer the commander’s questions. Predictive analysis will continue to be important, as the analyst, using a variety of media, presents possible and most likely enemy actions to the commander. Analysts must understand the analytical requirements of their units’ missions. These require-

ments range from engagement as part of a major regional contingency to treaty enforcement in an operation providing support and enhancing stability.

The threat in these situations will range from the known and predictable to ones that are lesser known with greater unpredictability. The 96Bs may begin building historical databases when their units arrive in theater or reach the areas to which they deploy. They must be able to adapt the analytical process to any situation that they confront.

We believe that 96B will continue to be the “flagship MOS” for Army MI in the future. Commanders will continue to turn to their intelligence organizations and analysts to provide a clear view of their areas of interest and operations.

Figure 1 shows where the 96Bs are serving in the Army. From private through master sergeant, the majority of the soldiers in each skill level (SL) serve at division and below.

	<u>EAC</u>	<u>CORPS</u>	<u>DIV</u>
MSG	12%	25%	63%
SFC	11%	23%	66%
SSG	10%	32%	58%
SGT	6%	26%	68%
PVT - SPC	17%	20%	63%

Figure 1. Where 96Bs Serve in the Force.

Beginning the Process

There is a tremendous amount of discussion about what the 96B Intelligence Analyst will need to know and be able to do to meet the demands of the commander in the future. For each SL, we—

- Defined what the 96B must be able to do as a "skill" and must know as "knowledge."
- Weighed heavily the input from senior NCOs (Staff Sergeants (SSGs) and Sergeants First Class (SFCs)).
- Surveyed 96B NCOs stationed at USAIC and those attending BNCOC.
- Attempted to arrive at answers to the questions most often asked.

We believed that the most likely assignments for each SL soldier are with the maneuver brigade S2 (E1-E4), brigade S2 (E5), battalion S2 and a brigade analysis and control team (ACT) NCO in charge (E6), and division G2 (E7). These assignments would determine both the S/Ks required for success and whether they would be best taught at USAIC or at the field units through distance learning. Again, our intent was to determine the S/Ks required of any 96B to best meet the demands of their most likely assignments.

As we built the S/K sets for each of those assignments, we began to see common subject areas. They included security, stability operations and support

operations, intelligence preparation of the battlefield (IPB), and the All-Source Analysis System (ASAS) Remote Workstation (RWS). To differentiate among the S/K sets for each SL, we adopted the terms "apprentice," "journeyman," and "master," to define the level of proficiency expected from each soldier in those S/Ks. Figure 2, our "Four-Corner Chart," enumerates the attributes of each SL, the set of S/Ks ("S" or "K") required of a 96B at that grade, and the level of proficiency necessary. See page 62 for an expansion of the acronyms in the figures.

Training Strategies

Before detailing the individual training strategies by SL, we crosswalked the required skills and knowledge by skill level with current training and determined the delta of the training in meeting the mandatory S/Ks. The group then developed the strategy for necessary training changes and development to meet the training delta.

Two points were especially important. We consulted with the NCOs from the 96B10 course, Noncommissioned Officer Academy (NCOA), Reserve Component Office, Directorates of Continuous Learning and Futures, and other units and organizations at Fort Huachuca and elsewhere. Then, we compared each training strategy repeatedly to other training strategies and the Four-Corner Chart to ensure that there is no unnecessary re-

dundancy and that the strategy supported the S/K requirements.

96B10 Training Strategy. The goal is to graduate an apprentice-level intelligence analyst capable of providing tactical intelligence to support the commander's battle plan at the maneuver brigade and at lower echelons. The 16-week course focuses on IPB, collection management (CM), intelligence reports and database management, situational development, and automation skills using the ASAS and the ASAS-RWS. The training will use a "crawl, walk, run" philosophy through realistic and demanding situational training exercises (STXs). The course comprises six blocks of instruction: basic skills, light brigade, heavy brigade, stability operations and support operations, the ASAS All-Source (ASAS-AS) system, and the end-of-course examination.

The **Basic Skills** block teaches map reading, symbology, operational terms, communications skills, and ASAS-RWS operation. Upon completion of this block, students can determine elevations and azimuths and read marginal information on military maps. They can translate information from intelligence reports, SALUTE (size, activity, location, unit, time, and equipment) reports and spot report messages into proper military symbology and use the message traffic to produce a situation map (SITMAP). The students learn military terms and use them properly during briefings, in textual products, in graphics, and verbally. They will also achieve a basic understanding of the ASAS-RWS and send and receive messages, manipulate databases, and prepare electronic overlays.

The **Light Brigade** block teaches soldiers about IPB, event templates and matrices, CM, intelligence databases, and situation development. At the end of this block, soldiers must demonstrate proficiency in IPB by developing terrain and weather analyses for light enemy and friendly forces from squad through

<p style="text-align: center;">96B10</p> <p>Attributes: Serve division and below (tactical) Does not operate alone Requires on-the-job training Will experience a CTC (reinforce)</p> <p>Skills and Knowledge: A-J Intelligence analyst (S) J -Translate intelligence report to SITMAP (S) A -Perform IPB (S) A -Contribute to ISM, R&S, etc. (S) A -RWS operations (S) A -Target tracking (S) J Information/database management (S) A TOC operations A -Briefing skills (S) A -Battle tracking (S) A Stability and support ops overview (K) A Intelligence System corps to Bde (K) A -Write Bde R&S plan (S) A Operate in an ACE/ACT (S) A Equipment operator/maintainer (S) A Security (information/physical) (K)</p>	<p style="text-align: center;">96B30</p> <p>Attributes: National, joint, combined, and lower units BNCOC graduate NCOIC of Bn S2 section and Bde ACT Can perform, lead, train all 10/20-level tasks</p> <p>Skills and Knowledge: J-M Intelligence analyst (S) J-M -ASAS operator (S) M RWS operator (S) J -Predictive analysis (close/deep battle) (S) J -Target development (S) J Task and access the Intelligence Systems (S) J -Execute collection management (S) J Stability and support ops intelligence support (S) J Lead S2 effort during staff MDMP (S) M Briefing intelligence products (S) J Research and use Army writing style (S)</p>
<p style="text-align: center;">96B20</p> <p>Attributes: Serve corps and below (tactical/operational) Will work with other 96Bs Will have CTC experience Can perform, lead, train all 10-level tasks</p> <p>Skills and Knowledge: A-J Intelligence analyst (S) A-J -ASAS/RWS (S) A-J -Predictive analysis (close battle) (S) A -Target identification (S) J Operate as part of a maneuver staff (S) J Draft collection plan Bde and below (S) J Build ISM at Bde and below (S) J Security (field SOP) (K)</p>	<p style="text-align: center;">96B40</p> <p>Attributes: Bde and higher units (national, joint, combined) P/L/T and supervise all 10/20/30-level tasks ANCOC graduate NCOIC S2 section Bde and ACR Division ACE</p> <p>Skills and Knowledge: M Senior enlisted analyst in ACE (leadership) (S) M Intelligence analyst (S) M -RWS/ASAS operator (S) M Works/integrates with all MI MOSs M Task and access the Intelligence BFA (S)</p>

Figure 2. Four-Corner Chart Showing Knowledge and Skills Required of 96B Analysts.

brigade levels, including both their weapons capabilities and unit tables of organization and equipment. They can graphically display a light, defensive opposing force (OPFOR) using that

enemy's doctrine, and produce light OPFOR defensive courses of action (COAs) based on a modified combined obstacle overlay and the OPFOR's tactical doctrine.

The **Collection Management** block teaches students to select named areas of interest (NAIs), identify OPFOR signature equipment, and develop indicators that will aid in confirming or denying

a particular OPFOR COA. They learn to identify intelligence and electronic warfare (IEW) systems and capabilities through CM techniques, produce a brigade-level intelligence synchronization matrix (ISM), and master the production and update of intelligence database documents (journals, order-of-battle workbooks, and SITMAPs). The soldiers can prepare and update battle damage assessment (BDA) charts using message traffic, maintain situational awareness, and track high-value targets (HVTs). They will then prepare analytical products on the ASAS-RWS that they had previously prepared by hand.

The **Heavy Brigade** block covers heavy unit IPB, event template and matrices, CM, intelligence reports, and situation development. Much of what the students learn is similar to that in the light force block but is applied at the U.S. heavy corps and below. After completing this block, soldiers can produce an ISM and collection plan for a heavy brigade as well as a reconnaissance and surveillance (R&S) plan at the maneuver-battalion level. They will provide their input to several paragraphs of an intelligence estimate and an intelligence annex. Based on the message traffic, they will create a graphic intelligence summary (INTSUM) using the ASAS-RWS.

The **Stability Operations and Support Operations** block includes two days of lectures, two days of tactical operations center (TOC) operations, and one day of briefings. The students learn to produce population status and demographics overlays and databases; develop documents about insurgent organization and tactics based on message traffic; and study preparation of insurgent COAs based on their IPB, tactics, and organization. The class will develop association and time/event matrices and link diagrams. To practice situation development, they produce a brigade R&S plan to confirm or deny the insurgent COA and maintain an incident map based on message traffic.

They also prepare a key facilities and targets overlay based on a vulnerability list. In the last portion of this block, the students prepare link and pattern analysis from the message traffic received.

The **ASAS-AS** block teaches basic operator skills that include system initiation and termination, overlay, message, and database operations and management. Soldiers learn some initial analytical skills such as making queries, situation development, and target alarm criteria, and the intelligence collection management (ICM) function. The students perform as analysts within the situational functional identity (Sit FI) and gain insight into the target analysis process, ICM, and functional manager functional identity.

The **End-of-Course Examination** includes a comprehensive written performance examination and a practical exam that requires a demonstration of the skills taught during the course. During the practical test, the students read both message traffic and SALUTE reports, translate this information into correctly plotted unit symbolology, and annotate other required overlay information on a SITMAP.

USAIC will develop 105 hours for **96B10 sustainment training**. This training will cover---

- Symbolology.
- ASAS-RWS and ASAS-AS operator skills.
- IPB (define battlefield condition, evaluate light and heavy threat division and below units, and determine COAs).
- CM (develop specific information requirements and specific orders and requests, and manage IEW systems at echelons corps and below (ECB)).
- Stability operations and support operations (practicing IPB and R&S planning).

96B20 Training Strategy. The goal is to develop a journeyman intelligence analyst capable of providing intelligence support to the brigade and lower echelons' maneuver staff. This block of in-

struction provides both AC and RC soldiers with the resources to sustain their SL 10 proficiency and trains them to perform with SL 20 proficiency. It focuses on IPB and CM processes, reinforces the highly perishable automation skills (ASAS-AS and ASAS-RWS), and strengthens weak SL 20 areas as identified by the 96B30 BNCOC diagnostic pre-test. The two primary methods used to disseminate the training materials will be a 96B homepage operated by USAIC and compact discs-read only memory (CD-ROMs).

USAIC will develop a total of 57 hours of materials for **96B20** sustainment training that will include brigade-level IPB specifically focused on predictive analysis and intelligence support to the decision support template. The CM portion will update the brigade collection plan, build the brigade ISM, and develop the brigade R&S plan. This training will also cover the ASAS system supervisor and alarm operations, stability operations and support operations unconventional threat, and a targeting section on identifying HVTs and determining BDA.

96B30 Training Strategy. The goal is to provide our NCOs with the technical, analytical, and managerial skills required for successful performance as SL 30 intelligence analysts. Students in the nine-week BNCOC receive training and evaluation in leadership, communication, and in the selected military and professional skills required to lead and train MI soldiers. The class covers Army Common Core training (e.g. leader training, combat skills, physical training, and marksmanship, and MOS-specific training with five blocks of instruction and two situational training exercises (STXs)).

The **ASAS-AS** block of the BNCOC teaches the NCOs how to supervise the powering of the system and to perform interactive node analysis and criteria files maintenance. An appraisal evaluates the students' performance in producing a doctrinal template, es-

establishing event alarms, maintaining a SITMAP, and querying the All-Source Correlated Database (ASCDB). The ASAS-RWS instruction covers its basic operation and continues throughout the course with the building and usage of student databases and their intelligence products. The students will use their ASAS-RWS databases for performing predictive and situation analysis during the STXs on the heavy brigade and on stability operations and support operations later in the BNCOC. In the 13-hour **U.S. Army Operations** block, the students identify and understand Army intelligence operations at EAC and review Army ECB intelligence operations. They will study U.S. Army doctrine on IPB, CM, and the targeting process in the **Mission Analysis** instruction.

This training culminates with the five-day Heavy Brigade STX. It comprises several practical exercises in building intelligence products that allow students to apply all they have learned. The students divide into teams of four for brigade TOC operations. At the beginning of this STX, the NCOs receive a national database, a country study, and "Road to War" background information. The exercise requires students to use an intelligence product checklist to prepare scheduled briefings, make target development products and nominations, and employ the ASAS-RWS to receive message traffic and to store all of their STX-related products.

The 96B BNCOC **Stability Operations and Support Operations** instruction consists of two parts: a 24-hour block on intelligence support to these types of operations that ends with a written examination followed by the related four-day STX. Each student TOC in the STX receives message traffic through the ASAS-RWS and will use it to prepare two intelligence reports and one INTSUM daily.

96B40 Training Strategy. The goal is to train intelligence analyst MI Corps NCOs at a resident MI

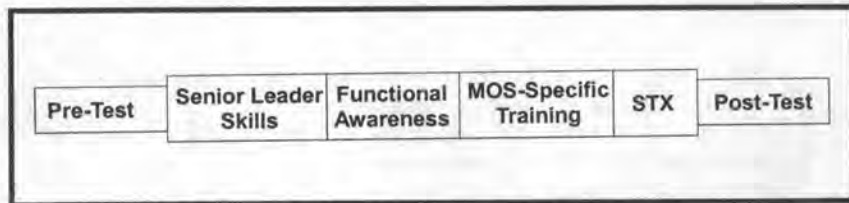

Figure 3. The Strategy and Model of the New ANCOC.

ANCOC (see Figure 3) to be leaders and trainers in a force projection environment that is challenging and performance oriented. Upon completion of this phase of training, these students will be technically proficient and capable of supporting the tactical commander's battle plan at division and higher echelons. USAIC built the new ANCOC course, which began in April 1998, on the following strategy and model:

- Use both pre- and post-tests to measure the NCOs' skills and knowledge.
- Focus on the S/Ks required of a platoon sergeant and a senior leader in a division analysis and control element (ACE).
- Look at those critical skills supporting the specific discipline and a multidiscipline view of all MI MOSs during the MOS-specific training.
- Use an Intelligence Center common scenario-driven performance-evaluation STX.

Reserve Component Training Strategy.

The goal is to train and sustain the RC units' 96B soldiers. We must ensure that they are capable of providing tactical-level intelligence support of the commander's battle plan at division (SFC) and maneuver brigade and lower echelons (SSG and below). Students must display S/Ks in—

- ASAS-RWS automation (as both an operator and analyst).
- Intelligence analysis in IPB, CM, and predictive analysis.
- Developing and maintaining intelligence databases and reports (SITMAPs, intelligence annex, intelligence estimate, and INTSUMs).
- Targeting in identification, development, tracking, and BDA.

The RC courses will ensure that the training meets the following objectives in a realistic, hands-on, and challenging environment:

- RC = AC (comparable training).
- Learn and apply new skills and knowledge using STXs.

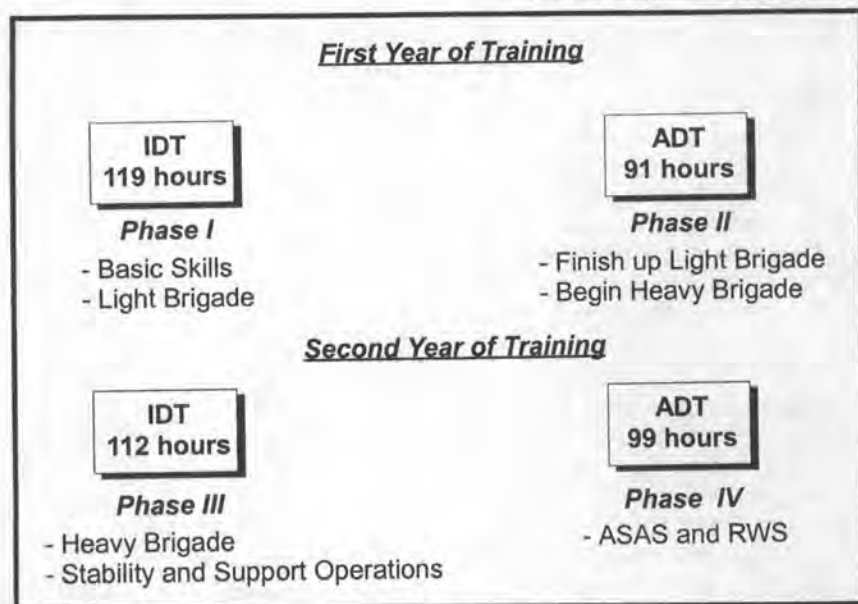

Figure 4. Example of RC 96B10 Training.

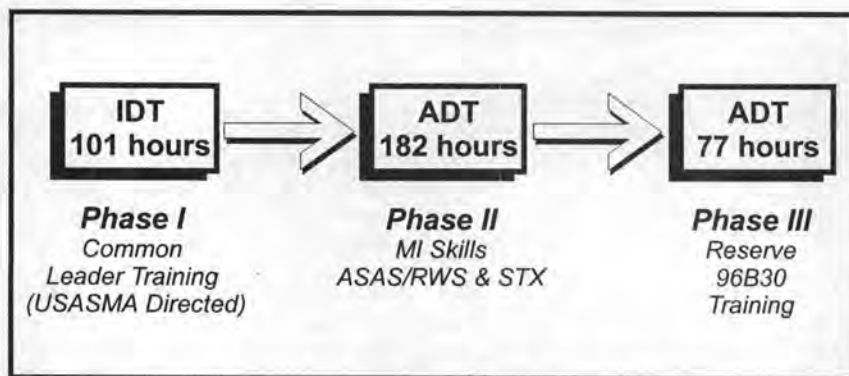

Figure 5. Reserve 96B30 Training.

- ASAS-RWS training using the resources of either the USAIC, U.S. Army Forces Command (FORSCOM), or both.
- Robust RC instructor training program integrated with AC USAIC instructors and courses.

Total Army Training System (TATS) Training Strategy

Figure 4 illustrates the recommended RC training flow for the 96B10 course. To develop this strategy, we crosswalked with what the 96B10 AC soldiers will be required to learn. We considered the realities of RC training and changed the flow and number of hours to train subject areas accordingly. For example, we built in time for review at the start of inactive duty training (IDTs) since RC soldiers will not have received training for approximately one month.

96B10 TATS training strategy. This training strategy will require approval because it extends over a two-year period. Execution of this strategy will necessitate training support from USAIC by allowing RC instructors to side-saddle with AC 96B10 instructors. Access to ASAS and the RWS must be coordinated.

96B20 TATS training strategy. This strategy will build a training program that the RC soldiers can really use. Whether the 96B20 is an AC soldier stationed in Alaska or an RC soldier living and working in Salt Lake City, the training materials will be made available to both.

96B30 TATS training strategy.

This strategy uses five IDTs conducted by the RC, and an active duty training session that would be held at one of the five Total Army School System (TASS) MI battalions (see Figure 5). Training is completed within one year.

Conclusion

The future success of 96Bs begins with the training they receive at Fort Huachuca. The 96B training strategy sets the course for the development of an intelligence analyst capable of meeting the demands of the future force. In accordance with the training strategy discussed in this article, changes to the 96B10, BNCOC, and ANCOC training are already underway. New MI soldiers will be training in TOCs for heavy brigade as well as stability operations and support operations. Skills previously taught using acetate now use the ASAS-RWS. Hands-on, scenario-driven exercises replace blocks of instruction that formerly provided only an overview of automation.

The NCOA continues to build a demanding 96B BNCOC. During the May BNCOC class, the NCOs developed intelligence pro-

ducts from the beginning of training that were critical to their success in STXs later in the course. The June 1998 iteration of the ANCOC had some of the most dramatic changes of any of the courses because it now trains and evaluates our senior NCOs in their specific technical skills. Focused on the Division ACE, the five-day end-of-course STX will have cells replicating the corps ACE, division ACE, and a counterintelligence/interrogation of prisoner of war cell in which NCOs with different MOSs should be able to operate successfully. As we continue to build better training for all 96B soldiers, we will scrutinize the training strategy constantly to ensure it continues to reflect the training needed for our 96Bs to meet the demands expected of them in the future.

Lieutenant Colonel Quinn is the Assistant to the Chief, Military Intelligence. He is currently a member of the Department of the Army Deputy Chief of Staff for Intelligence Intel XXI Study Task Force. LTC Quinn has served primarily at division-level and below; his command assignments have included the 309th MI Battalion at Fort Huachuca, Arizona; 511th MI Troop, 11th Armored Cavalry Regiment, Fulda, Germany; and company command with the 4th Training Brigade, Fort Jackson, South Carolina, and the 109th MI Battalion, 9th Infantry Division, Fort Lewis, Washington. LTC Quinn has been the Deputy G2 in Korea and the Division Artillery, 9th Infantry Division in Fort Lewis, Washington. He served two tours in the Pentagon serving as an Intern with the Joint Chiefs of Staff, Action Officer on the Army Staff, and most recently as the Intelligence Officer for the Director of the Army Staff. LTC Quinn has a Master of Science degree from Kansas State University. Readers can reach him via E-mail at quinnt@huachuca-emh1.army.mil.



Read Any Good Books Lately?
We welcome reviews of books related to intelligence professional development or military history. Please mail or E-mail your book reviews with your phone number, address, the title, author, publisher, price, and number of pages to the address on the table of contents page.

USAIC&FH

Foreign Language Initiatives

СПОСОБНОСТЬ

教學



by Lieutenant Colonel
Peter A. Shaver (USA, Retired)

USAIC&FH (U.S. Army Intelligence Center and Fort Huachuca) is working on several language-related initiatives designed to support MI linguists. The Advanced Individual Skills (AIS) Language Team provides development, enhancement, and sustainment training in language proficiency programs for MI Corps linguists. The Team is also involved in some projects that will offer MI soldier-linguists the capability to achieve technical foreign language sustainment while at their

units. These include distance learning language instruction, a technical language evaluation and training support package for linguists, and a language homepage on the Internet. These products will aid linguists and their units—both Active and Reserve Component—in maintaining and improving their valuable skills.

Foreign Language Instruction Via Distance Learning (FLIDL)

The AIS Language Team in the USAIC&FH Directorate of Continuous Learning has contracted

with the University of Arizona (U of A) to develop a technical language distance learning program. The program will provide MI linguists with the ability to sustain their technical foreign languages without having to leave their units. We chose Russian as the proof-of-concept language due to the availability of both linguists and subject matter expertise.

The U of A program developers wrote the web-based, interactive program with eight separate modules that include technology, economics, science, society, culture, military, security, and a summary module. Each module contains

five lessons that enhance the soldier-linguist's technical language skills of listening, reading, writing, speaking, translation, interpretation, information extraction, and "gisting." Linguists interact daily with the instructor and other students by E-mail, audio conferencing, and Internet chat boards. Russian linguists will be able to access the program through the Internet or by using compact disk-read only memory (CD-ROM) and Netscape internet browser (3.0 or 4.0) at their home and unit computers.

Russian linguists from the U of A Russian Language Department designed the program using the latest foreign language instructional methodology. They succeeded in linking several tasks that encompass various skills. For example, an article or lesson may link both listening and reading tasks. In addition, the developers have supplied the soldier with Internet links to Russian media and a full grammar textbook as references. Students proceed through the program with instructions given in Russian and at their own speed; however, the goal is to complete a minimum of five lessons per week.

We have conducted two pilot programs at Fort Huachuca, Arizona, and Goodfellow Air Force Base in San Angelo, Texas. The first experimental group will be at Fort Carson, Colorado, from 20 July through 11 September 1998. We invite all Russian linguists at the 1+ or 2 levels to participate in future groups. Russian FLIDL will be available to units by fiscal year 2000 (FY00); we will add other languages to the program as resources allow. Contact the author at (520) 538-1042, DSN 879-1042, or E-mail shaverp@huachuca-emh1.army.mil for further information.

Language MOS Evaluation Plan (LMEP)

The LMEP provides a technical language evaluation and training support package (TSP) for all MI linguists. Using the LMEP, unit

commanders can administer a battery of exams to their soldiers that test specific, integrated military occupational specialty (MOS) and linguist-related tasks. Based on the testing results, commanders can identify skill areas requiring remediation and develop focused training schedules.

After assessing the linguists' technical language skills with the evaluation tool, the commander or the Command Language Program Manager (CLPM) will assign specific components of the TSP for the linguists to complete. The TSP will offer MI linguists interactive, integrated language and MOS-task-based training easily accessed on a CD-ROM platform. The program incorporates realism and vibrant graphics using current *Toolbook™* technology. Some of the more salient TSP features include visual and aural vocabulary drills, audio map tracking, an interactive interrogator notebook, screening, document exploitation (DOCEX), and interrogation exercises.

We have developed a prototype LMEP package for Korean-speaking human intelligence (HUMINT) linguists based on Interrogator MOS 97E. The signals intelligence (SIGINT) LMEP (MOS 98G) offers a set of exams that test skills in traffic identification, transcription and translation, hand-scanning, and reporting. We will develop an interactive TSP in the next six months.

In cooperation with the Fort Lewis Foreign Language Center, the Language Team is responsible for designing and incorporating language training into the program. The AIS LMEP coordinator for the Language Team will distribute the program for validation in late summer 1998 to units with Korean-speaking HUMINT soldiers. The coordinator will also send a letter of instruction (LOI) to commanders and linguists on the correct usage of the program and a questionnaire to gather validation data. For further information or to participate, contact Staff Sergeant

Robert Laposta at (520) 538-1038, DSN 879-1038, or via E-mail lapostar@huachuca-emh1.army.mil.

MI Foreign Language Center (MIFLC)

The AIS Language Team has created a language homepage for MI linguists throughout the MI Corps. Linguists will be able to link to language sites that will give them current language training and information, and access to current audio and visual media sources. In the future, they will include links to live instruction in specific languages. The resources that are currently available on the site include a comprehensive language-training guide in 13 languages, an MI language newsletter, language refresher course dates, Defense Language Proficiency Test schedules, and a guide to the meaning of the DLPT levels. Interested readers may access the homepage through the Fort Huachuca Continuous Learning homepage at <http://huachuca-usaic.army.mil/contlearning/ais/index.html>. Readers can contact the homepage developers, First Lieutenant Scott Hensley and SSG Marc Stephens at (520) 520) 538-1040, DSN 879-1040, and via E-mail at hensleys@huachuca-emh1.army.mil and msteph@primenet.com, respectively.

Lieutenant Colonel Pete Shaver is currently the Chief, AIS Language Team, Directorate of Continuous Learning, and the 97L Translator/Interpreter Course Manager. His previous civilian assignment was as a Foreign Language Instructor, Jordan School District, Sandy, Utah. His military positions included Language Training Officer, 300th MI Brigade, Utah National Guard, and at 5/104th Battalion, U.S. Army Reserve; he was also a Course Manager at Fort Huachuca. LTC Shaver has a bachelor of arts degree in French from Utah State University and a master of arts degree in French and International Studies from the Monterey Institute of International Studies, Monterey, California. He also has Secondary Teaching Certificates from Utah and California. Readers can contact him as stated above.



The National Cryptologic School Adjunct Faculty Program

by Larry N. Hampton

Mission, technology, and tools are becoming more complex and demanding. Simultaneously, dwindling resources mean that there are fewer people around to do the same or an increased amount of work. All of this points to a burgeoning need to provide quality, timely training to the remaining workforce. However, those same resource constraints often mean a reduced capability to train—diametrically opposite of the need. So, what is a beleaguered commander or training manager to do?

The Department of Defense National Cryptologic School (NCS) has answered this question in part by creating and administering an initiative called the Adjunct Faculty Program. This voluntary program creates and fosters a dynamic, flexible, professionally competent solution to cryptologic and related training requirements. Adjunct Faculty Program members augment the resident NCS faculty by providing a cadre of professionally qualified subject matter experts (SMEs) who assist the NCS by teaching, developing, managing, or evaluating courses in one or more fields.

The NCS Adjunct Faculty Program consists of National Security Agency/Central Security Service (NSA/CSS) military and civilian personnel who meet certification criteria. Those criteria include—

- Completion of the 40-hour NCS ED-101 course (Training Methods for Cryptologic Instructor) or Service equivalent. (For example, individuals certified from the Army's Basic Instructor Training Course (BITC) who hold the "H" designator are not required to take ED-101.)
- Graduation from the course or courses for which the individual wishes to become adjunct-certified.
- Team-teach the course at least once with a certified instructor.

To remain active, the Adjunct must teach a course at least once every two years and maintain subject matter currency. Additionally, if individuals desire to design a course as Adjuncts, they must also complete the NCS ED-170 course (Developing Objectives and Tests) and ED-181 (Instructional Programs Development).

There are several other recommended NCS courses, but they

are not necessarily required for Adjunct certification. They are—

- ED-125 Conducting On-the-Job Training.
- ED-126 Managing OJT.
- ED-190 Introduction to Needs Assessment.
- ED-205 Distance Learning Teaching Methods.

There are currently more than 5,000 certified Adjunct Faculty Program members at 65 locations worldwide. Those members are qualified to teach approximately 500 different courses in a curriculum including such diverse subjects as languages, collection management, analysis, reporting, computer skills, and cryptologic equipment maintenance.

Adjunct Faculty Program members provide multiple benefits to the commanders in the field. A certified Adjunct Faculty Program member is an SME and is competent in training techniques and knowledgeable about training-delivery methods to adult students. These trainers perform their real-world missions for the unit in addition to the voluntary training duties. More people can receive training and certification at the unit than the unit could otherwise have afforded.

Given the NCS's success in this area, other agencies are in various stages of establishing adjunct faculty programs. The Defense Intelligence Agency (DIA), Federal Bureau of Investigation (FBI), and National Imagery and Mapping Agency (NIMA) are all developing similar programs.

For more information on taking full advantage of the NCS Adjunct Faculty Program, getting personnel in your unit Adjunct-qualified, or becoming an Adjunct Faculty

member yourself, contact your local NCS Education and Training Officer. You may also contact the NCS Adjunct Faculty Program Managers at Fort George G. Meade, Maryland. Call commercial (410) 859-6234 or DSN 244-623 and ask for Senior Airman Lintz, Mrs. Pat Stivers, or Ms. Sue Marney.

Mr. Hampton is a professional cryptologist with more than 20 years' experience. He is currently serving as the National Security Agency/Central Security Service Representative (NCR) to Fort Huachuca, Arizona. His prior service includes assignments in the Army Security Agency and the U.S. Army Intelligence and Security Command (INSCOM). Mr. Hampton holds a bachelor of arts degree in Russian Area Studies from the University of Maryland (European Division). Readers may contact him via E-mail at hamp-ton1@huachuca-emh1.army.mil or telephonically at (520) 538-6344 or DSN 879-6344.

AI Device

(Continued from page 27)

active or reserves, national guard, or soldiers from the other Services—could interact with the simulated world, and it provides an excellent standards and evaluations tool, an "MI Gun-nery." Most importantly, I have

attempted to show a coherent, workable plan to automate human intelligence operations, now and into the future, and thereby enhance intelligence's force multiplier capability.

Major Jeff Girard is currently the 1st Battalion Signal Officer assigned to 10th Mountain Division (Light) Fort Drum, New York. His most recent position was Chief, Artificial Intelligence Section, Infrastructure Branch, Continuous Learning Directorate, at Fort Huachuca. Major Girard has a bachelor of science degree in Computer Science from the United States Military Academy and a master of science degree in Artificial Intelligence from Duke University.

What the Fort Knox Threat Manager's Office Can Do For You

The Fort Knox Threat Manager's Office is the Armor Center's Senior Intelligence Office, responsible for threat and intelligence support for material and doctrine development, and technical oversight of threat-related training for the mounted force.

The Threat Manager is responsible for—

- Developing and maintaining expert knowledge of current and projected foreign weapons systems, equipment, organization, doctrine, and tactics with emphasis on the threat to the armored force.
- Promoting, developing, overseeing, instructing, and evaluating threat training at every level of schooling.

The Threat Manager is privy to information for the combat elements and in the process sets the armor unit S2s up for success. Here are a few examples of what we can provide for you:

- Threat armor-related products to support exercises and real world deployments. By monitoring trends and projections in threat doctrine, organization and technology, we can provide updated products not normally available to brigade and battalion S2s.
- Threat instruction to U.S. Army Reserve and U.S. Army National Guard units during monthly drills.
- Threat training literature.
- Briefings to Officer/Noncommissioned Officer Professional Development classes for USAR and ARNG units.
- Armor threat bulletins, reports, and briefings to the mounted force.

Our goal is to bridge the gap between national-level intelligence agencies and the mounted force. If what you need relates to threat armor capabilities, we can help. For further information, send a message with your inquiry to the Threat Manager, Captain Tom Meyer (E-mail Meyert@ftknoxdfd-emh13.army.mil) or call us at (502) 624-7563, DSN 464-7563, or STU-III-8842. You can also visit the Fort Knox Threat Manager Webpage at <http://know-www.army.mil/center/threat/intel.htm>.



Distance Learning: Intelligence Training for the 21st Century

by Lieutenant Colonel
George A. Wheat

Distance learning is "the delivery of standardized training to soldiers and units at the right place and right time through the application of multiple means and technologies."

—Total Army Distance Learning
Plan, 3 April 1996

As the world heads into the next millennium, the Army and Military Intelligence (MI) are on the verge of a new revolution in training and learning. With the 1996 publication of the **Total Army Distance Learning Plan**, the Army formalized its program for the use of technology—specifically interactive technology—in what had previously been primarily a research project by several diverse organizations and academia. The advent of the personal computer (PC) in the late 1970s brought about a revolution in our approach to office automation, making our routine, complex, time-consuming tasks simpler and much more efficient. As our understanding of these new capabilities advanced, so did the technology.

Today, the realization of the Internet and Worldwide Web, as well as the corresponding advances in computer software and technology, has had a similar effect on our view of **Education** and **Training**. Digitization of

everything from simple words and graphs to audio and full-motion video has changed how we perceive the learning experience. We have the ability to manipulate, customize, or build from scratch engaging and challenging lessons that can be presented on a PC right in our own offices or homes. We can deliver this same learning experience over several different media just by changing the packaging. At the U.S. Army Intelligence Center and Fort Huachuca, we are beginning to institutionalize many of these methods of learning technology in an effort to make the same quality training available to a vast majority of MI soldiers worldwide.

Total Army Distance Learning Program (TADLP)

The TADLP vision is to provide training to the entire force—soldier, leader, and unit; active and reserve component; military and civilian workforce—through a virtual schoolhouse, or “classroom without walls.” The U.S. Army will deliver this training at the right place and time by various technological means to enhance our overall readiness. To accomplish this, the Army has established plans to build expanded networks and distance learning (DL) centers and facilities throughout the

United States and around the world wherever our troops deploy. This network will furnish access to new interactive courseware and digitized lessons, as well as providing the more familiar training via video teleconferencing or video-teletraining. This plan also establishes standards for the design, development, and delivery of training in the various DL styles and media. The ultimate goal is to decentralize training execution: push training out from the proponent schools to several satellite facilities and unit locations.

Intelligence Center DL Vision

Our DL vision is to build a “schoolhouse without walls” (see Figure 1) through the delivery of high-quality training that provides an engaging and challenging learning experience. With the recent changes in the world political and socioeconomic environments, the future threats and situations that we will face as a military force are still somewhat uncertain. In this environment, there will be a greater demand for training that is tailored to specific situations and delivered to units at their home stations. The DL products developed at the Intelligence Center (USAIC) must be able to adapt to meet this demand.

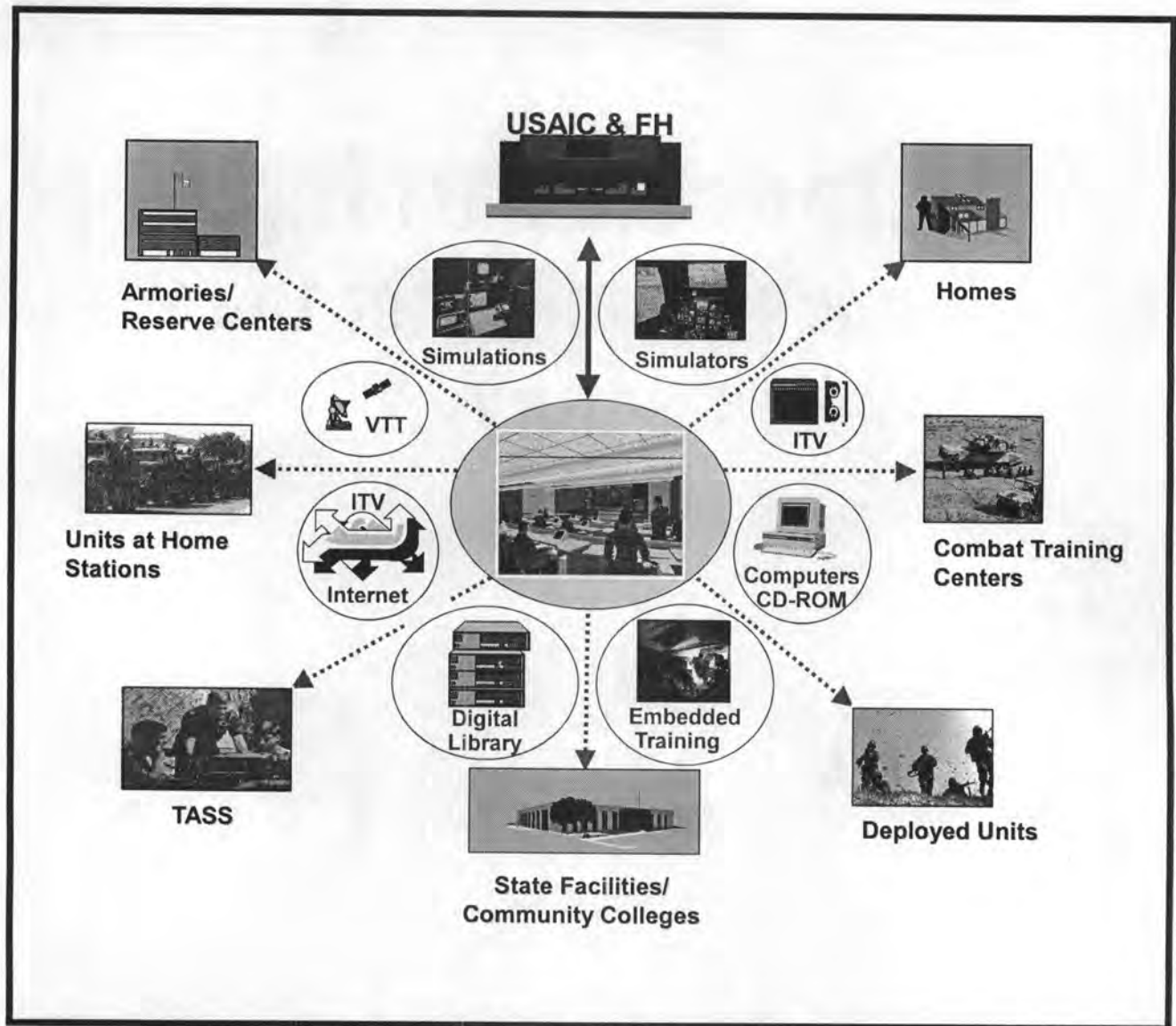

Figure 1. Schoolhouse Without Walls.

To maximize the resources available (time, money, personnel), USAIC is seeking to achieve economies in training by using DL for delivery of lecture-type materials that require little interaction with the instructor or other students. There are far too many required skills to be learned than can be adequately taught in the time available. During the cradle-to-grave analyses of training needs for each enlisted military occupational specialty (MOS) and officer specialty, the work groups identify those tasks suited to this type of presentation. While redesigning our resident programs, the Intelligence

Center is focusing on the skills and "knowledge sets" the MI soldier will require in the year 2010. This will necessitate refining those skills that enhance their cognitive thought and analysis abilities, and adding new skills associated with other joint and national intelligence systems where appropriate. The development of nonresident prerequisites and homework (outside duty hours) assignments are crucial to avoiding any increase in training time as a result of redesigning the resident courses. In other words, the USAIC strategy is one of "cost avoidance" rather than "cost reduction."

Distance Learning Media

The media selection for delivery of DL lessons is as essential in the design of the final product as the objective that must be satisfied by the training. Use of the wrong delivery technique can detract from the anticipated learning experience causing the training audience to miss completely the intended learning objective. By definition, DL allows for a broad interpretation of the types and styles of media that training developers can apply. They range in sophistication from simple paper-based correspondence courses to hybrid, multimedia, computerbased instruction. Understanding the in-

herent capabilities and limitations of each type of media is critical to ensuring proper lesson development and delivery. The selection of the appropriate media for the lesson or course is a crucial step in the delivery of high-quality training.

Print. This is paper-based, bound materials offering both text and graphics delivery designed for asynchronous, one-way delivery of information that is generally non-interactive and non-perishable in nature. The Army intends to reduce the amount of its printed materials as the means and materials that support advanced DL technologies are more widely instituted. This medium is relatively inflexible and costly to adapt to meet new training requirements.

Video-teletraining (VTT). VTT is real-time video and audio delivery of primarily graphical information. Designed for synchronous, two-way, interactive instruction, the VTT is capable of one-way monitoring with resident assistance to facilitate collaborative learning. This media is the most flexible for rapid development of training to support emerging requirements. However, different instructors may not present the training materials in precisely the same manner during repeat

broadcasts, resulting in training variances that may be significant.

Computer-Based Training/Computer-Aided Instruction (CBT/CAI). CBT/CAI are digitized training materials delivered via an electronic medium and operated on a computer workstation. The electronic medium can include compact disc-read-only memory (CD-ROM), digital tape, and various types of diskettes. This method offers flexible, easy to manipulate training data, but it is more costly and less responsive to updating lessons than is the VTT. CBT/CAI provides an asynchronous, interactive environment for learning based on the scope and complexity of the lesson software and renders a standardized presentation of the material every time.

Web-Based Training. This training method employs on-line, digitized training materials operated on a computer workstation and delivered over an electronic network by file transfer mode or in on-line execution. This medium provides standardized presentation and allows for the frequent update of course material. Use of electronic mail, chat sites, and desktop teleconferencing offers both synchronous and asynchronous collaboration by multiple personnel at numerous dispersed locations.

Development Methodology

When talking about delivering training or instruction with DL products, it is important to understand that the distance is irrelevant. It may be training a unit on a peacekeeping operation on the Sinai Peninsula 12,000 miles away, or it can be 300 feet down the hall to a classroom full of students. The ultimate goal is to deliver a consistent standard of training to the entire force independent of their unit locations. USAIC plans to use four means for developing courses that meet this goal: internal development, contract development, use of existing products, and modification of existing products.

We are currently developing our migration plan to facilitate conversion of current and new training requirements into a DL format. This plan includes providing a total USAIC solution through global access to existing training capabilities (see Figure 2).

Internal Development. The USAIC approach to internal development of DL courseware is to bring together a team of experts for a programmed period to build a specific DL product. These experts include personnel with subject matter knowledge, specialists in learning theory, graphic and



Figure 2. USAIC Distance Learning Migration Plan.

visual information artists, and computer technicians and scientists. The synergy gained when such experts work side-by-side to design and develop the product should ensure that timely and appropriate learning objectives are produced. The staff of the USAIC, Directorate of Continuous Learning, Distance Learning Office (DLO) comprises a permanent nucleus of personnel with these unique skills augmented by selected subject matter experts (SMEs) at the beginning of each project. We identify the SMEs, who work in other elements within the center and school, and have them assigned to the team for the duration of the project's development. Upon completion of their projects, the SMEs will return to their units and normal duties with updated skills and an understanding of DL tools and development methodologies. The addition of the SMEs enhances our ability to maintain the currency of previously developed lessons.

Contract Development. Analysis of Total Army Training System Conversion (TATS-C) courses is conducted internally; the U.S. Army Training and Doctrine Command (TRADOC) provides the funding for TATS-C courses. USAIC contracts the TATS-C course development with a firm having the capabilities and proven expertise in developing interactive multimedia instructional (IMI) products. Currently, the Ground Surveillance Radar Operator Course (96R10) is under contract for development of 33 hours of on-line IMI products, thus reducing the resident portions of the course by approximately four days. Other IMI projects approved for fiscal year 1999 (FY99) are the development of 76 hours for the Reserve Component (RC) MI Officers Advanced Course (MIOAC-RC) and 20 hours for the RC MI Warrant Officers Advanced Course (MIWOAC-RC). These products will use standardized templates for delivery to maintain a consistent appearance and function-

ality throughout most of the lessons in support of Intelligence Center courses.

Use of Existing Products. Several organizations within the Intelligence Community have existing DL courses that can meet the needs of some of the Center's training objectives. During the cradle-to-grave analysis process, the working groups identified many for possible use in meeting this training need. An example is the courses developed by the National Cryptologic School (NCS) and used to support the training of MI soldiers in career management field 98 (CMF 98). We can evaluate these lessons and courses for applicability and incorporate them into the training strategy to meet specific needs. By doing so, several training requirements can be satisfied with little cost for development.

One major aspect of this method requiring coordination is the tracking of student enrollment and completion notification. The DLO and the USAIC Registrar are attempting to create an electronic, seamless method whereby the student, NCS, and the Intelligence Center Registrar receive notification simultaneously. This is a complex problem; its solution will evolve as our understanding of the technological capabilities expands.

Modify Existing Products. The fourth means for developing DL products is to modify existing courseware from both internal and external sources. Based on current training requirements, we can modify, revise, and update these products to accommodate the latest procedures and practices in use. The obvious advantage is that production of the product requires less time than for one developed from the ground up. The disadvantage to this approach is that generally only the "owning" organization accomplishes modifications to its courseware, and that the cycle of review and the ability to affect changes are subject to approval outside the Intelligence Center.

Course Design

For every course designed, the developers must complete a phased approach to ensure that it presents the proper learning objectives and the target audience can attain the desired results. These steps—analysis, configuration, design, and development—apply to all courses, both in residence and via distance learning. These four phases comprise the product development cycle.

Analysis. The analysis phase of course design elaborates on a critical task list by taking the task's conditions and standards and identifying the observable behaviors a person performs when executing this critical task. Then learning analysis looks at where the trainers create the performance environment within the constraints of the learning environment. A media analysis to replicate the performance environment and an audience analysis to identify the target population complement the learning analysis.

Configuration. Configuration focuses on how training developers and instructors will manage, maintain, and administer a course. DL courseware is frequently delivered asynchronously so that the mechanisms for registration, automated grading (sometimes called computer-managed instruction), and electronic feedback—both automated and from a mentor—are especially important. Content management is equally important because courseware often needs updating. Content management tools make updates easier to manage because global changes are possible.

Design. The beginning point (where we are) and the end-point (where we want to be) are determined during the analysis phase; design is the "road map" for how we get there. The design is a set of components or a series of events a student must complete. The events are generated by a number of factors, but are dictated by one of two broad instructional

(Continued on page 61)

To the Editor:

That was a great article by Captain John Chenery on the need for S2s to put together a good terrain board for their commanders and staffs ("The Terrain Model: A Miniature Battlefield," *MIPB* October-December 1997). I have a couple of points to add that take his article a little further.

When I was the Brigade S2 of 3d Brigade, 1st Cavalry Division, we had a terrain board kit that served us well during a National Training Center (NTC) rotation and the preceding train-up. We carried the kit in two wooden howitzer shell boxes on top of our track. Similar to Captain Chenery's kit, we had a white rope (grid lines), black rope (phase lines), colored rope (axis of attack or battle positions), and cans of spray paint. However, instead of colored, acetated 3- by 5-inch cards (prone to blow away as he points out), we used 1/4-inch-thick white plastic squares and rectangles that had been cut from a 4' by 8' sheet of white plastic. We had two sets of numbers completed with the 2-inch high black stick-on numerals on 3-inch squares for the grid line marking. We used the 3- by 5-inch rectangles for enemy and friendly units and battlefield control measures. The plastic cleaned

off easily with alcohol or water (depending on the type of marker used), was easy to see from anywhere around the board (when we used thick markers), and stayed put when placed on the ground.

- Main terrain features of the area of operations (AO)
- Gridlines and gridline numbers
- Friendly boundaries
- Phase lines
- Directions of attack
- Battle positions
- Engagement areas
- Position areas for the artillery
- Target reference points
- Objectives
- Named areas of interest:
 - Red—brigade constant obstacles
 - Blue—brigade as acquired
 - Green—division obstacles
 - STAR (surveillance, target acquisition, and reconnaissance) team locations—brigade scouts by any other name
- Enemy unit locations (all):
 - Templated (dashed outlines)
 - Confirmed (solid outlines)
 - Directions of attack
 - Battle positions (down to motorized rifle platoons)
 - Time phase lines

Figure 1. Terrain Board Checklist.

The noncommissioned officers and assistant S2s would use a checklist to make sure that the board was ready for the war-game or rock drill. The terrain board checklist included everything shown in Figure 1.

I hope that this explanation of our tactics, techniques, and procedures (TTP) helps some S2s out there.

Major Rich L. Holden, Jr.

Wuerzburg, Germany

To the Editor:

I am currently researching my father's military service and came across your page on the Internet. My father served in World War II with the 14th Armored Division as an Assistant G2 and as the S2 of the 645th Tank Destroyer Battalion.

I realize that much has changed since those days. However, I appreciate the basic articles that you have offered in your web site, as they provide me with a sense of his responsibilities. Thank you.

Theodore E. Phillips

Farmingdale, New York

Share Your Photographs

To better support your articles, we request that our readers send photographs of MI operations, equipment, and exercises. These photographs should be copyright free. Include the full name of the photographer, and a brief note explaining what is in the picture. They can be color or black-and-white, and they should be clear and in focus. Please include a way for us to contact the photographer. Provide a return mailing address, and we will return the photos if so requested.



U.S. Army photo

Military Intelligence Corps Association

by Colonel John H. Black
(USA, Retired)

Members of the Military Intelligence Corps formed the MI Corps Association (MICA). It was organized on 2 November 1994 at Fort Huachuca, Arizona. The intent of MICA is for intelligence professionals to provide a forum through which members can share ideas and experiences as well as to continually upgrade the profession.

MICA is dedicated to supporting a high level of esprit de corps and proficiency among those in the intelligence profession by sponsoring various programs such as the:

- MI Intelligence Museum.
- Knowlton Award.
- Scholarships for enlisted MI soldiers.
- The MICA "Vanguard" newsletter.
- Subscriptions to the *Military Intelligence Professional Bulletin (MIPB)* as a part of the membership benefits.



We sponsor receptions and other get-togethers in conjunction with conferences and meetings. In addition, many of the local MICA chapters enhance professional development by such means as the fine guest speakers at luncheon meetings and special dinners, and information-sharing like the Colorado Chapter's "MICA-Gram." This article provides information on some of the MICA programs that support of the MI Corps.

MI Museum

The Army Intelligence Museum at Fort Huachuca is a central repository for those historical items that help put the MI story into per-

spective. The museum came to fruition due to the dedication of the U.S. Army Intelligence Center and Fort Huachuca museum staff, the vision and support of the former USAIC&FH Commander, Major General Charles W. Thomas, and the hard work and funding provided by MICA. The Intelligence Museum—dedicated on 2 November 1995—resulted from a true team effort.

The museum's mission is to preserve and transmit the experiences and values of those who have gone before. The resultant knowledge will not only better equip MI's current stakeholders to carry out their professional duties, but enrich them with a sense of belonging to a larger tradition with common goals and shared values.

Since its opening, MICA, with the financial support of six MICA corporate members, has sponsored the establishment of a second exhibit hall that features displays about the Korean War, the Vietnam conflict, and human intelligence "tradecraft" artifacts. MICA

also established the Knowlton Room, a meeting and research room located in the museum. The Knowlton Room features a current list of Knowlton Award winners, some historical and intelligence-related books and periodicals, and taped interviews with current and former senior MI officers and Hall of Fame inductees. Donations from three MICA corporate members furnished the room.

We do encourage all of you to visit the Army's Intelligence Museum during your next trip to Fort Huachuca. It is located at the corner of Christy and Hungerford Avenues, in Building 41411. The museum, operated by volunteers, is open from 1000-1400 hours, Monday, Wednesday, and Friday. The building also includes a small gift shop containing MI-related items.

Knowlton Award

One of our most well received programs has been the establishment of the Knowlton Award, named for Lieutenant Colonel Thomas Knowlton, the official hero of the MI Corps and MICA. LTC Knowlton commanded the first intelligence and reconnaissance unit in the United States Army during the Revolutionary War. We regard the creation of that unit as the birth of U.S. military intelligence. The Knowlton Award acknowledges demonstrated excellence or superior support to MI. Currently, all Active and Reserve Component G2s/J2s and MI commanders in the rank of LTC or higher, installation senior intelligence officers (SIOs), and any MI colonel or general officer can approve the award.

The MI Corps Hall of Fame ceremony in 1995 marked the first presentations of the Knowlton Award. Since then, many deserving officers, noncommissioned officers, and civilians have received Knowltons at many retirement and award ceremonies. The award is a medallion with an MI blue ribbon, worn around the neck on special occasions. You undoubtedly

have noticed this award proudly worn at various MI balls, dinings-in, and other special occasions.

MICA Scholarships

We think that the MICA Scholarship program is unique. We offer scholarships to MI enlisted soldiers who are pursuing their educational goals. We have granted two scholarships each year since the program was established.

MICA is on an annual application cycle. The cut-off date for acceptance of applications is 31 May each year. Application packets are available from the MICA national headquarters. See page 63 of the April-June 1998 issue of *MIPB* for more detail on this program and application procedures.

MICA Home Page

Visit the MICA home page on the Internet at <http://www.primenet.com/~usamica/>. There are many features on the home page that you may find interesting. They include:

- A very comprehensive list of open-source resources.
- The catalog and order form for the MICA Gift Shop.
- Expanded information on the Knowlton Award and Scholarship program (standing operating procedures and blank forms).
- Membership applications, MICA chapter information, and information about our corporate members.

Our goal is to expand the MICA website to include a larger number of services available only to MICA members. Current plans include:

- An on-line mentorship program to link volunteer senior officers and NCOs with junior officers, noncommissioned officers, enlisted soldiers, and civilians. Do you want to be a mentor? Contact the MICA webmaster.
- Virtual chapters that target interest groups—linked through

the website—rather than geographical areas.

- A possible on-line supplement to MIPB updated continuously with articles, tips, and techniques submitted from our entire membership.
- A resume service to provide low-and-no-cost resume construction and posting to the MICA site.
- Much, Much, More !!

Conclusion

MICA has made great progress since it began three years ago. We are all very excited and proud about what we have accomplished. However, there is still much to be done and we need your input to do it. Let us know if you have any ideas on how we can improve and grow. You are probably asking yourself: What can I do? How can I help? If you are not a member, you can join MICA. Next, you can support your local chapter. If a local chapter does not exist, then help start one.

MICA will continue to participate in the overall evolution of the MI Corps. We remain excited about our numerous accomplishments and momentum we have exhibited. If you desire additional information, write to MICA, P.O. Box 13020, Fort Huachuca, Arizona 85670-3020. You can also call the author, MICA's National President at (520) 458-9759 (daytime) or (520) 378-0209 (evenings); fax us at (520) 803-9000; or send E-mail to 103525.1562@compuserve.com

Colonel Black is the National President of MICA. While on active duty, he served in numerous command and intelligence positions in Vietnam, Korea, Germany, the Middle East, and the United States. One of his last was as Chief of Staff at USAIC&FH. During Operation DESERT STORM, he served on the Third Army G2 staff where he devised the IEW Synchronization Plan and Matrix. COL Black has a master of arts degree in National Strategy from the Naval War College and a Master of Business Administration from Idaho State University; his bachelor's degree in History was from Fort Lewis College in Colorado. COL Black works for a defense contractor as a project manager for All-Source Analysis System (ASAS) software.

by Stephen B. Leeder

In the last issue of the *Military Intelligence Professional Bulletin*, the Doctrine Department article described the reorganized doctrinal development process. The Doctrine Division, Futures Directorate, U.S. Army Intelligence Center and Fort Huachuca, implemented this revised process in July 1998. The process began with the formation of a writing team to revise **FM 34-7, Intelligence Support to Stability and Support Operations**. As was mentioned in that article, one of the most important components of the revised doctrine development process is still your active participation.

The Counterintelligence/Interrogation Doctrinal Initiative and FM 34-7

Our division is experimenting with an unofficial partnering initiative as a new means to effectively gather and integrate field units' input. The goal is to build closer relationships with the units in the field and to identify and fill doctrinal shortfalls—primarily specific tactics, techniques, and procedures (TTP). The XVIII Airborne Corps and 10th Mountain Division have graciously agreed to an unofficial partnership to identify and fill some doctrinal shortfalls based on their experiences in Bosnia. This partnering initiative involves counterintelligence (CI) and interrogation TTP primarily (but not exclusively).

This initiative started with a video teleconference (VTC) between the Intelligence Center, the XVIII Airborne Corps, and the 10th Mountain Division in June. The VTC resulted in identification of a number of shortfalls, and we developed an integration plan to fill these shortfalls. The integration plan involves many

manuals but most significantly affects **FM 34-7; FM 34-60, Counterintelligence; and FM 34-52, Intelligence Interrogation**. The timing is excellent because the update of these manuals is in the planning or early development stages. Our division is confident that this doctrinal initiative will help to shape these manuals, especially those portions with CI and interrogation TTP.

While many partnering possibilities exist in the future, your participation in doctrine development is still critical. The Futures Directorate considers **FM 34-7** an essential manual due to the large number of stability and support-type operations that the Army has conducted recently and will encounter in the near term. It will require considerable input from the field to ensure that this manual is valid and detailed enough for each category of operation. The writing team needs stability and support operations input: lessons learned, specific examples and scenarios, briefing slides, standing operating procedures (SOPs) and TTPs, and examples of intelligence products used.

Maximize Your Input

We will welcome your input at anytime on any of the 34-series manuals. The writing teams will incorporate them into the appropriate manuals as we revise them. However, there are two critical stages in the doctrine development cycle where comments most effectively help to shape the revised manual: field units' input is critical during the pre-revision review and the initial draft review. As these manuals are in the pre-revision review and initial draft stages, we will staff them on the Intelligence Doctrine Homepage. This homepage at <http://138.27.35.36/Doctrine/dlb.htm> is your doctrinal review tool.

Your comments are very crucial to the doctrine development process. To maximize the effectiveness of your comments:

- Make sure you have read and understand intelligence doctrine. An informed comment is always the best comment. Often your comments reaffirm the fundamentals established in our body of doctrine as valid and adequate.
- Differentiate recommended changes to doctrinal fundamentals from revision to generic and unit-specific TTP and SOPs. In most manuals, there is often room for more specific TTP and examples of the application of fundamentals. For example, a recent survey on the intelligence preparation of the battlefield (IPB) process recommended the use of more specific examples in certain scenarios. Additionally, doctrine and TTP must apply to the entire Army, not to a specific unit.
- Provide specific comments. Usually blanket comments are of less value than comments that refer to a specific sentence. While the use of a DA Form 2028 (Recommended Changes to Publications and Blank Forms) is not a requirement for your comments, we do request that you reference the page and line numbers.
- Justify your comments. Although your comment is clear to you, the rationale is not always apparent to the reviewer. An unemotional and logical justification helps the reviewer to see your logic.

Conclusion

As the Intelligence Center moves forward with doctrine while addressing newer doctrinal developments like information operations, Force XXI concepts, and

emerging doctrinal issues, we must maintain contact with the field. Our division must maintain close coordination with the real "motorpool" Army so that we can serve as your conduit to the doctrinal development process. While

partnering initiatives should help in this endeavor, we still need all units' active participation.

Mr. Leeder is a senior doctrine writer in the Doctrine Division, Futures Directorate. He is leading the writing teams for developmental FMs 34-10-5/ST, Division XXI

IEW Operations; 34-80-1/ST, Force XXI Brigade Intelligence Operations; and FM 34-10, Division IEW Operations. Readers can contact him about this article via his E-mail at leeders@huachuca-emh1.army.mil.

PROPONENT NOTES

Warrant Officer Recruiting Update. Recently, the U.S. Army Recruiting Command (USAREC) published an updated **Warrant Officer Application Checklist and Sample Packet**, Volume V, dated April 1998. This packet is an excellent step-by-step reference that consolidates all applicable regulations into a single publication that outlines all warrant officer application requirements. One major change is the dollar amount of a traffic violation requiring submission of a request for a moral waiver. The reportable amount was raised from \$100.00 to \$250.00.

USAREC also has a web site at www.goarmy.com/warrant/warrant.htm that offers a sample packet and applicable forms; it details the prerequisites for each

military occupational specialty (MOS). If MI applicants cannot find the answers to the questions they may have using the checklist, web site, or local military personnel office (MILPO), they should contact Chief Warrant Officer Five Rex Williams, the Office of the Chief, Military Intelligence (OCMI), Warrant Officer Professional Development Manager. You can reach him at (520) 533-1183, DSN 821-1183, or via E-mail williamsx@huachuca-emh1.army.mil.

Officer Advanced Course Branch Mix Program. Opportunities exist for selected MI officers to attend the advanced courses of other Army Branches. MI is responsible for providing one officer to each Infantry, Armor, Air Defense, Engineer, Aviation, and Ar-

tillery Officer Advanced Course. Submit applications to the Captains' Assignments Officer at MI Branch, at the U.S. Total Army Personnel Command (PERSCOM). For more information contact Captain John Sanders at E-mail sanderj1@hoffman-emh1.army.mil.

Potential candidates must have tactical experience and a strong manner of good performance. Assignment officers will make recommendations to the Chief of the Military Intelligence Corps for final approval. This program is open to both male and female officers. The point of contact for more information is Captain Cal Downey, (520) 533 1180 or DSN 821-1180. He can also be reached via E-mail at downeyc@huachuca-emh1.army.mil.

MI CORPS HALL OF FAME

Colonel Sydney Forrester Mashbir (Deceased)

Discipline: Linguist/Interrogator
HOF Inductee 1988

In 1904, Colonel Mashbir was a 13-year-old bugler of B Company, 1st Arizona Infantry (Arizona National Guard) in the Arizona Territory (Statehood came in 1912). Early in 1916, he became the Assistant Intelligence Officer of the Ajo-Yuma District. That fall he commanded K Company, 1st Arizona Infantry.



U.S. Army photos

Accepted in the regular Army, he transferred to the 2d Infantry at Governors Island, New York. On 10 September 1917, he worked with the Department Intelligence Officer at the post. On 6 November 1917, he received a promotion to captain (permanent) and on 9 October 1918 another to major (temporary).

While there, he noticed a large number of German immigrants in the Coastal Artillery and he had them investigated. In August 1917, while searching the quar-

ters of Paul Otto Kuno, a non-commissioned officer (NCO) in the Coastal Artillery, they found a key to a safety deposit box that led to a log Kuno kept on various coastal batteries. The log included technical details concerning the operation of the batteries. Kuno was interned until the end of the war.

On a detail to Syracuse University, New York, after World War I, COL Mashbir became its first professor of Military Science. In 1919, the War Department approved his request to study Japan. In 1920, he submitted a handbook on Japan with a request for transfer to a post in Japan. In August, he went to Japan for a four-year course of study in Japanese; while studying, he was attached to the Military Attaché Office. He transferred to the Coastal Artillery Corps on 4 October 1921.

In 1922, he developed the "M-Plan," a means for getting information out of Japan during war. He resigned from the Army in 1923 so that he could implement his plan while working for a civilian firm in Japan.

In 1923, COL Mashbir returned to the United States but was unable to re-enter the Army because of a change in the law. Then in 1927 the War Department ordered him to active duty. While in the office of the Assistant Chief of Staff G2, he re-wrote the order of battle manual on Japan. In 1937, he returned to Japan as a civilian. In 1941, he knew that the War Department would not implement his M-Plan; by then he had left the Army.

Then, after the attack on Pearl Harbor, he received a commission in the Signal Corps and took his oath of office on 24 January 1942. In September 1942, he flew to Australia to join General Douglas MacArthur's staff as a linguist. In 1943, he was the head of the Allied Translator and Interpreter Section (ATIS).

The ATIS was the most prolific of the three collection and analytical agencies in the Southwest Pacific Theater. During World War II, the ATIS linguists translated more than 20 million pages of captured documents and interrogated 14,000 prisoners. ATIS attached many of its linguists to Army, Corps, and division G2s, where they provided invaluable combat information to the front-line commanders.

After the fall of the Philippines, COL Mashbir—still the head of ATIS—also performed linguistic duties in MacArthur's executive group. To counter Japanese domestic propaganda, the ATIS began shortwave broadcasts from the Philippines. During the Japanese surrender in August and September 1945, COL Mashbir served as General MacArthur's translator.

He left Japan in early December for an assignment with the Office of the Adjutant General of the Army. COL Mashbir retired in 1951.



**Chief Warrant Officer
Four William T. Ragatz
(Deceased)**

**Discipline: Signals Intelligence
HOF Inductee 1990**

Chief Warrant Officer Four Ragatz entered active duty in February 1953, serving initially as the S2 Sergeant with the 317th Engineer Battalion (Combat) in Germany. After attending

the Defense Language Institute, he became an operations sergeant in the 502d Communications Reconnaissance Group. As a young NCO, he was the chief of a section ensuring the accuracy and smooth flow of product reports during the 1956 Soviet invasion of Hungary. Following further training at Fort Devens, Massachusetts, CW4 Ragatz became the Collection Chief-Watch NCO for the U.S. Army Field Station in Bad Aibling, West Germany.

After returning to Fort Devens as an instructor, his warrant officer appointment became effective and, in 1965, he became the Collection Officer at the U.S. Army Field Station, Hakata, Japan. During this tour, CW4 Ragatz went to Korea to provide expertise and assistance after the capture of the USS Pueblo. For three months, he worked nearly around the clock to ensure that U.S. Cabinet-level policymakers had accurate and timely intelligence concerning the Pueblo crisis.

In 1968, he became the Collections Officer for the 330th Radio Research Company, South Vietnam. He maximized his limited resources to provide optimum intelligence support to all I Field Force combat units in Vietnam.

He next served as the Collection Officer, U.S. Army Security Agency Field Station, Herzogenaurach, West Germany, and in the same position at the 7th Radio Research Field Station, Thailand. In Thailand, his unit received the National Security Agency's Travis Trophy as the best signals intelligence (SIGINT) unit worldwide.

Returning to the United States in 1973, CW4 Ragatz served as Academic Division Chief at Fort Devens before attending the Warrant Officer Senior Course. In 1976, he transferred to Fort Huachuca, Arizona, where he developed and taught warrant officer training at the U.S. Army Intelligence Center and School (USAICS). During the next six

years, CW4 Ragatz wrote the initial program of instruction for the first Warrant Officer Advanced Course, and he served as the Senior Faculty Advisor, Course Director, and also as the SIGINT Instructor.

After retiring from active duty in February 1982, William Ragatz worked as a civilian contractor in intelligence-related fields in private industry for two years. In July 1984, he returned to

USAICS as a Department of Army civilian in the Directorate of Combat Developments. While working in the Fielded Systems Branch, Tactical Software Division, he made use of his years of experience, working with battle-field automated intelligence and electronic warfare systems in the application of tactical software development. He specifically worked on the Interim SIGINT Single-Source Processor.

Major General Sidney T. Weinstein, the U.S. Army Intelligence Center and School Commander at the time, selected him as part of a small team of MI experts. They wrote and briefed "The MI Story" to major commands worldwide.

CW4 Ragatz is widely recognized as one of the drivers of the present-day SIGINT processing architecture. For his operational contributions, he remains a legend in the MI Corps.

ASAS Master Analyst Program Sly Fox Den ASI 1F Notes



The U.S. Army Military Intelligence Corps is offering a unique program to provide commanders with specially trained intelligence analysts. We designed this program, the All-Source Analysis System (ASAS) Master Analyst Program (AMAP), to meet the challenges of advanced automation and the demands of MI senior noncommissioned officers. A special branch at Fort Huachuca leads and coordinates all aspects of the program.

Military personnel active in the program must contact and coordinate with the AMAP office periodically. This ensures that units know about many critical events occurring throughout the force. Important issues include unit problems, lessons learned, school requests, assignment opportunities, and program changes.

As of 1 July 1998, the program comprises 24 active members. The total Army requirement is currently 80 authorizations with more to come as the AMAP success story spreads. The next two ASAS Master Analyst Course (AMAC) classes will begin in October 1998 and February 1999. Each class has a capacity of 12 students and is in the Army Training Requirements and Resources System (ATRRS).

Effective 1 October 1998, all students must pass a basic-level certification test on one of the three ASAS systems: all source, single source, and remote workstation. The basic task lists for

ASAS have been published on our web site (see URL <http://138.27.202.66>). Successful performance on the test is a requirement for continuation in the course. Soldiers unable to meet the certification criteria will be returned to their units.

To improve the ASAS Master Analyst Course training at Fort Huachuca, the Deputy Commanding General of the U.S. Army Intelligence Center and Fort Huachuca has resourced a special training laboratory for the AMAP. This "lab" will provide a greater opportunity for students to learn advanced skills and a "hands on" ability to apply new knowledge. The Software Engineering Directorate of U.S. Army Communications-Electronics Command has agreed to help with this project. This crucial facility will provide the AMAP and CECOM with an excellent forum for training and collaborative opportunities involving ASAS.

The first of July 1998 marks the program's first anniversary. AMAP is still getting on its feet and the road ahead is very bright. In our first year, we got the AMAP charter approved and the necessary agreements formalized, and developed and designed the course. Most important, the "sly foxes" are serving proudly in the force, ready for the future—today.

Master Sergeant Michael Fallon is the Chief of the AMAP. For more information, readers can contact him via E-mail at amap@huachuca-emh1.army.mil, telephonically at (520) 533-4652 or DSN 821-4652, and through the web page at <http://138.27.202.66>.

CI/HUMINT Automation—Step One

by Colonel Jerry V. Proctor

Some will say that it is long overdue, but the Army's counterintelligence and human intelligence (CI/HUMINT) world finally is joining the All-Source Analysis System (ASAS) automation world. Beginning in April 1998, the ASAS CI/HUMINT Automation Team Set (CHATS) conducted its Limited User Test (LUT) at Fort Gordon, Georgia.

CHATS

First, what is CHATS? CHATS is based roughly on the U.S. Army Europe (USAREUR) Theater Rapid Response Intelligence Package (TRRIP). It consists of a commercial off-the-shelf (COTS) Laptop P166®, draft Defense CI Information System message formats (explained later), digital camera, printer, scanner, communications interfaces, and soon, a STU-III (Secure Telephone Unit-Third

Generation) telephone, all enclosed in an airline overhead-size, hardened suitcase. The total weight is about 40 pounds.

CHATS is an acquisition success story. Essentially, it went from the "good idea" stage to the physical "box-in-hand" in less than 18 months. Building upon this success and the clear need for such a capability in the field, CHATS achieved interim fielding authority while awaiting its operational test. Consequently, as I prepare this article, U.S. Army and U.S. Marine CI/HUMINT soldiers have received more than 100 CHATS devices.

The CHATS represents only one of a four-part ASAS CI/HUMINT effort. The other three pieces are—

- CI/HUMINT functionality in the command post analysis and control element (CP-ACE). This is the CI workstation designated for integrating products into the all-source picture.
- Next, at the appropriate MI units, there will be a CI or interrogation operations work-

station. In addition to working with CI/HUMINT products, this workstation will perform much of the CI/HUMINT asset management.

- Finally, for individual CI/HUMINT team members, ASAS will provide a palm-sized reporting device.

These three devices are currently under development.

DCIIS

Standardized reporting and databasing of CI/HUMINT are evolving as CHATS undergoes fielding. The Defense Intelligence Agency is migrating the CI part of the Migration Defense Intelligence Data System (MDIDS) into a national CI/HUMINT database called the Defense Counterintelligence Information System (DCIIS).

DCIIS consists of both national and regional servers through which Army CI/HUMINT soldiers will input and draw data. DCIIS is also in its testing phase, and we expect implementation this fall.

Conclusion

With DCIIS and ASAS automation will come significant changes in operations for CI/HUMINT soldiers. The U.S. Army Intelligence Center and Fort Huachuca is energetically planning training upgrades to accommodate ASAS automation and DCIIS.

All of these changes represent a major leap forward in CI/HUMINT reporting and operations and a great improvement in the all-source products provided to the maneuver forces.

Colonel Jerry Proctor is the Training and Doctrine Command System Manager for ASAS (TSM-ASAS). Readers can contact him via E-mail at proctorj1@huachuca-emh1.army.mil or telephonically at (520) 533-3504 and DSN 821-3504.

Subscription Renewal

If you notice a "#" or "*" at the bottom of your address label, then it is time to renew your subscription. The "#" means you have one more issue coming, the "*" indicates that this is your last issue. You can renew either by calling us at (520) 538-1015 or DSN 879-1015 (with a credit card handy) or by sending us the completed subscription form on page 14. If you wish to keep your magazine intact, then make a photocopy of the form to send us. Below is an example of how a label would look when it is time to renew.

Captain John Q. Public
3219 East Stevens Road
Sierra Vista, AZ 85635-2290

*

PROFESSIONAL READER

The Attaches by Major General Charles Francis Scanlon (USA, Retired) (Fairfax Station, VA: IM Press, Inc., 1997), 381 pages, \$29.95.

In a recent conversation with this book reviewer, MG Scanlon stated that the reason for writing his book, *The Attaches*, was to give the reader a flavor for the U.S. Army's Foreign Area Officer (FAO) program currently absent in Service manuals or related documentation. Specifically, he wanted to provide a resounding endorsement of the FAO program and to highlight the importance of the Defense Attache Service (DAS). Through this book, he does both exceptionally well.

In writing *The Attaches*, MG Scanlon has made a lasting professional contribution by telling the Defense Attache story. Although the book is a fictional adventure novel, he points out that the story is inspired by actual events during his tenure as former Director of the DAS.

The book's storyline is relatively simple. In the thawing Cold War setting of the

mid- to late 1980s, the book takes the reader on the globe-trotting exploits of Bert Lowe, the recently appointed director of DAS. His worldwide excursions include stops at many American embassies and their supporting defense attache offices, which form the backdrop for a look into the DAS. Interwoven into the plot is the search for a Central Intelligence Agency (CIA) spy who is wreaking havoc on the DAS and CIA. By piecing together bits and pieces of information obtained through his attaches and other reporting sources, Bert is able to eventually discover and apprehend the spy.

The Attaches does give the reader a true feel of attache work. FAOs and attaches can relate to the events described because they are all covered: from the attaches' unique training and abilities, to their reporting responsibilities, the relationships between the embassy country team members, the contacts, representational housing, the important role of spouses, the cocktail parties, and the intrigue, allure, hardships, and challenges of working in a foreign country. This by far is

the most important contribution that the book makes. By peering into attache offices, the reader discovers the essence of the attache system.

For a young officer considering FAO as a functional area (FA 48) and more specifically defense attache work, this book is must reading. For someone looking for a Tom Clancy-like adventure novel, stick to Tom Clancy. But remember the reason for this. In keeping with a storyline that is based on true events, the author stays true to reality. Unfortunately, this may not produce the James Bond antics in an Ian Fleming or Clancy fictional novel. If you want to experience the same type of effect, just note the major difference between Clancy fiction and Clancy nonfiction (documentary) books; the former is fun reading, while the latter educates and informs. MG Scanlon's book is the latter type and, from that perspective, it is a tremendous contribution to the professionalism of DAS.

Colonel Victor M. Rosello
Fort Gordon, Georgia

Distance Learning:

(Continued from page 52)

strategies: expository or experiential. Frequently, the design phase will include "story boards" arranged as a map of the course flow. Training designers build their DL courseware using software-authoring tools; content templates often result as an outcome of the design phase.

Development. The development phase populates the templates with the subject matter content. The content that is framed within these templates is linked throughout the courseware using the authoring software. There is considerable room for error when authoring courseware because of the complexity and frequency of links between content, templates, and media. The development phase is a process of building, testing, and debugging, resulting in courseware that is ready for validation.

In designing courses for DL requirements, determining the appropriate media and methods of delivery are essential to ensuring

an effective learning environment. Application of proper learning theories and development of appropriate testing tools are equally important to ensuring that the students attain a proper level of competency for the learning objectives presented.

Conclusion

The Intelligence Center established the Distance Learning Office (DLO) (a division of the Directorate of Continuous Learning) to be the focal point manager and developer of all Intelligence Center DL products. The DLO is working to produce high quality, Internet-delivered, next-generation courseware for the entire Intelligence Community. This effort should posture the Military Intelligence Corps for success well into the next century. For more information contact Mr. Iorizzo or Sergeant First Class Goins at (520) 538-1024, DSN 879-1024, or via E-mail goinst@huachuca-emh1.army.mil.

Lieutenant Colonel Wheat began his long career in special operations after his initial assignment as infantry and anti-

tank platoon leader and company executive officer with the 25th Infantry Division in Hawaii. Following completion of Special Forces training, LTC Wheat served as a Special Forces Operational Detachment-A Commander, Company Executive Officer, and Special Forces Company Commander in the 5th Special Forces Group at Fort Bragg, North Carolina. He then served more than five years in a special mission unit as the chief trainer and exercise officer. He was a Battalion S2/3 and Battalion Executive Officer at the U.S. Army John F. Kennedy Special Warfare Center School. At U.S. Special Operations Command Central, he served as a Ground Operations Officer; Chief, Operations Plans Division, Operations Directorate; and as the first Liaison Officer to the U.S. Central Command Headquarters. During his tenure, he was involved in planning special operations for the U.S. responses to numerous Iraqi military activities and the United Nations military withdrawal from Somalia. In August 1997, after completion of his joint tour, he became the first Chief of the DLO. LTC Wheat is currently the Deputy Director and Chief of the Advanced Collective Skills Division, Directorate of Continuous Learning, at the U.S. Army Intelligence Center and Fort Huachuca. He earned a Bachelor of Science degree in Geography at the University of Alabama. Interested readers can contact LTC Wheat via E-mail at wheatg@huachuca-emh1.army.mil.

Glossary

of the acronyms used in the figures on pages 4 through 52

5D IMINT	5-dimensional IMINT (database)	ASI	additional skill identifier
AA	air assault	ASM	audio switch matrix
AAR	after action review, after action report	ATRRS	Army Training Resources and Requirements System
ABN	airborne	BASIX	brigade all-source intelligence exercise
ACCP	Army Correspondence Course Program	BCT	basic combat training
ACE	analysis and control element	BCTP	Battle Command Training Program
ACR	armored cavalry regiment	BDA	battle damage assessment
ACS	advanced collection skills	BNCOC	Basic Noncommissioned Officer Course
ACT	analysis and control team	BOIP	basis-of-issue plan
ADT	active duty for training	C²	command and control
AE	aerial exploitation	C²W	command and control warfare
AEPDS	Advanced Electronic Processing and Dissemination System	CAD	course administrative data
AGCCS	Army Global Command and Control System	CAS³	Combined Arms and Services Staff School
AGM	attack guidance matrix	CGS	Common Ground Station
AHFEWS	Army High-Frequency Electronic Warfare System	CBT	computer-based training
AI	artificial intelligence	CD-ROM	compact disc-read only memory
AIS	advanced individual skills	CGSC	Command and General Staff College
AIT	advanced individual training	CI	counterintelligence
Amps	amplifications	CINCOS	Change in NCO Structure
AMSS	Automatic Meteorological Sensor System	CLPM	Command Language Program Manager
ANCOC	Advanced Noncommissioned Officer Course	CLT	common leader training
AOC	area of concentration	CM	collection management
AQF	Advanced QUICKFIX	COA	course of action
AR	armor	COINS	Community On-Line Intelligence System
ARL	Airborne Reconnaissance Low	COMINT	communications intelligence
ARTEP	Army Training and Evaluation Program	COMSAT	communications satellite
AS	all source	CONMSG	contingency message
ASAS	All-Source Analysis System	CPX	command post exercise
ASAS-AS	All-Source Analysis System-All-Source	CRS	Common Remoted System
ASAS-CCS	All-Source Analysis System-Command and Control System	CSM	command sergeant major
ASAS-RWS	All-Source Analysis System-Remote Workstation	CSTAR	Combat Synthetic Test and Training Assessment Range
ASAS-SS(W)	All-Source Analysis System-Single Source (Workstation)	CSU	conventional signals upgrade
ASAT	Automated Systems Approach to Training	CTAC	Cryptologic Training Advisory Committee
ASCDB	All-Source Correlated Database	CTC	Combat Training Centers
		CTS	career training strategy
		CTT	Commanders Tactical Terminal
		DISE	deployable intelligence support element

DLP	distance learning program, distance learning package	IEWCS	Intelligence Electronic Warfare Common Sensor
DLPT	Defense Language Proficiency Test	IEWTPT	IEW Tactical Proficiency Trainer
DOCEX	document exploitation	IMETS	Integrated Meteorological System
DS	direct support	IMINT	imagery intelligence
DTSS	Digital Terrain Support System	I-REMBASS	Improved Remotely Monitored Battlefield Sensor System
EAC	echelons above corps	INTELINK	Intelligence Link (system)
ECB	echelons corps and below	INTSUM	intelligence summary
ELINT	electronic intelligence	IPB	intelligence preparation of the battlefield
EPB	electronic preparation of the battlefield	ISDC	Intelligence Support to Division and Corps
EPDS	Electronic Processing and Dissemination System	ISM	intelligence synchronization matrix
ETRAC	Enhanced Tactical Radar Correlator (TENCAP system)	ITDB	Intercept Tasking Database
ETUT	Enhanced Tactical Users Terminal (TENCAP system)	ITN	informal technical notes
EPW	enemy prisoner of war	ITV	interactive TV (television)
E-TRACKWOLF	Enhanced TRACKWOLF	JCM	Joint Conflict Model
EVAC	evacuation	JCMT	Joint Collection Management Tools
F3S	Field Station Support System	JDISS	Joint Deployable Intelligence Support System
FA	functional area	JMIC	Joint Military Intelligence College
FAST	Forward Area Support Terminal (TENCAP system)	Joint STARS	Joint Surveillance Target Attack Radar System
FIRESTORM	Federation of Intelligence, Re- connaissance, Surveillance, and Targeting, Operations, and Research Models	JTF	joint task force
FISINT	foreign instrumentation signals intelligence	JTT H3	Joint Tactical Terminal Hybrid 3 (replaces CTT)
FLIDL	Foreign Language Instruction via Distance Learning	LCSP	Life Cycle Support Plan
FORNSAT	foreign satellite	LMEP	Language MOS Evaluation Plan
FS	field station	LMRDFS	Lightweight Man-Transportable Radio Direction-Finding System
FTX	field training exercise	LOI	letter of instruction
FY	fiscal year	MDMP	military decision-making process
GBCS	Ground-Based Common Sensor	METL	mission essential task list
GBCS-H	GBCS Heavy	MICAT	Military Intelligence Combat Assessment Tables
GBCS-L	GBCS Light	MIDB	Military Intelligence Database
GRCS	Guardrail Common Sensor	MIES	Modernized Imagery Exploitation System
GS	general support	MIFLC	MI Foreign Language Center
GSM	Ground Station Module (Joint STARS) (CGS precursor)	MITT	Mobile Integrated Tactical Terminal (TENCAP system)
GSR	ground surveillance radar	MOS	military occupational specialty
HPW	high-performance workstations	MRC	major regional contingency
HPT	high-priority target	MSG	master sergeant
HUMINT	human intelligence	MTP	mission training plan
ICDH	Intercommunication Data Handler	NAI	named areas of interest
ICW	in conjunction with	NCO	noncommissioned officer
IDT	inactive duty for training (Reserve Component)	NCOES	NCO education system
IET	initial entry training	NCOIC	NCO in charge
IEW	intelligence and electronic warfare	NCS	National Cryptologic School
		NETT	new equipment training team

NSA	National Security Agency	SPC	specialist
NTTC	Naval Technical Training Center	SQL	standard query language
OAC	officer advanced course	SS	single source
OPELINT	operational ELINT	SSRW	Senior Span ROFA West
OPFOR	opposition force	STP	soldier training publication
OPLAN	operations plan	STRAPS	system training plans
OPMS	officer personnel management system	STX	situational training exercise
OPORD	operations order	TACELINT	tactical electronic intelligence
OSIS	Open-Source Intelligence System	TACOM	Theater Army Command
OTC	Officer Transition Course	TACREP	tactical report
PC	personal computer	TACSIM	Tactical Simulation
PCC	Pre-Command Course	TASS	Total Army School System (RC)
PE	practical exercise	TATS	Total Army Training System
PER	personality characteristics	TDA	table of distribution and allowance
PERSCOM	U.S. Total Army Personnel Command	TECHINT	technical intelligence
PGIP	Postgraduate Intelligence Program	TENCAP	Tactical Exploitation of National Capabilities
PIR	priority intelligence requirement	TES	Tactical Exploitation System (TENCAP system)
PLDC	Primary Leadership Development Course	TEXIN	TEXTA information
PMAD	personnel manning authorization document	TEXTA	Technical Extracts from Traffic Analysis
PMCS	preventive maintenance checks and services	TI	technical inspection
POEREP	position effectiveness report	TMDE	test, measurement, and diagnostic equipment
POI	program of instruction	TOE	table of organization and equipment
PVT	private	TOC	tactical operations center
QQPRI	Qualitative and Quantitative Personnel Requirements Input	TPC	tactical proficiency course
R&S	reconnaissance and surveillance	TROJAN SPIRIT	TROJAN Special Purpose Integrated Remote Intelligence Terminal
RC	Reserve Component	TRRIP	Theater Rapid Response Intelligence Package
RFI	request for information	TSP	training support plan, training support package
ROFA	Remote Operating Facility Airborne	TSS	target selection standards
ROK	Republic of Korea	TUAV	Tactical UAV
RSOC	Regional Security Operations Center (formerly "SIGINT")	UAV	unmanned aerial vehicle
SOCOM	U.S. Special Operations Command	USAIC&FH	U.S. Army Intelligence Center and Fort Huachuca
SGM	sergeant major	USAREC	U.S. Army Recruiting Command
SIGINT	signals intelligence	USASMA	U.S. Army Sergeants Major Academy
SIMLINK	Simulations Link	USSID	U.S. Signals Intelligence Directive
SIR	specific information requirement	V/R	virtual reality
SITMAP	situation map	VTC	video teleconference
S/K	skills and knowledge	VTT	video-teletraining
SL	skill level	WARNET	Warfighter Network
SOP	standing operating procedure	WARSIM	Warfighter Simulation
SOR	specific orders and request		

702d Military Intelligence Group

Oriental blue and silver gray are the colors traditionally used by military intelligence units. The grid-lined sphere highlights worldwide capabilities and the millennium eagle represents strength and tenacity through the next one thousand years. The key and quill pen above the eagle's head represent the key to knowledge and the cryptologic elements within the 702d. The lightning bolts beneath the eagle represent the electronic means by which the 702d gathers its intelligence. The unit's motto, "Sentinels of the Warfighter," symbolizes the unit's commitment to providing timely intelligence in support of deployed commanders worldwide.



Activated on 1 November 1995, the 702d Military Intelligence Group is one of the newest units within the U.S. Army Intelligence and Security Command. Although the unit may not have a long history, the soldiers are on the cutting edge of the information age and are already providing outstanding support to deployed warfighters. The unit's soldiers, stationed in two stateside locations, support two Regional Security Operations Centers (RSOCs). RSOCs provide national-level information, which is continuously analyzed and disseminated to combat commanders.

The command and control headquarters for this conduit of information is Headquarters and Headquarters Detachment, 702d Military Intelligence Group, located at Fort Gordon, Georgia. The Group's two military intelligence battalions process, validate, and disseminate critical intelligence information.

The 721st Military Intelligence Battalion at Fort Gordon directly supports the Gordon Regional Security Operations Center (GRSOC). The 721st, whose motto is "Distant Vigilance," is comprised of two companies. The first, Headquarters and Headquarters Company (HHC), provides the habitual command, control, and support requirements necessary to operate the battalion. The second, A Company, 721st MI Battalion, is made up of the linguists and analysts needed to accomplish the Battalion's unique mission supporting the GRSOC.

The 748th Military Intelligence Battalion, located at Lackland Air Force Base, Texas, supports the Medina Regional Security Operations Center (MRSOC). The 748th, known as "The Alamo Station," comprises three companies. The HHC provides the command and control, while A Company and B Company provide linguists to support the MRSOC.

Thus, the 702d Military Intelligence Group is uniquely designed to implement national command authority missions at a moment's notice. This unique design places the Group at the Vanguard of information superiority now and well into the next century.

SENTINELS OF THE WARFIGHTER

Commander
U. S. Army Intelligence Center & Fort Huachuca
ATZS-CLM (12)
Fort Huachuca, AZ 85613-6000

BULK RATE
POSTAGE & FEES PAID
CLAYSBURG, PA 16625
PERMIT NO. 6

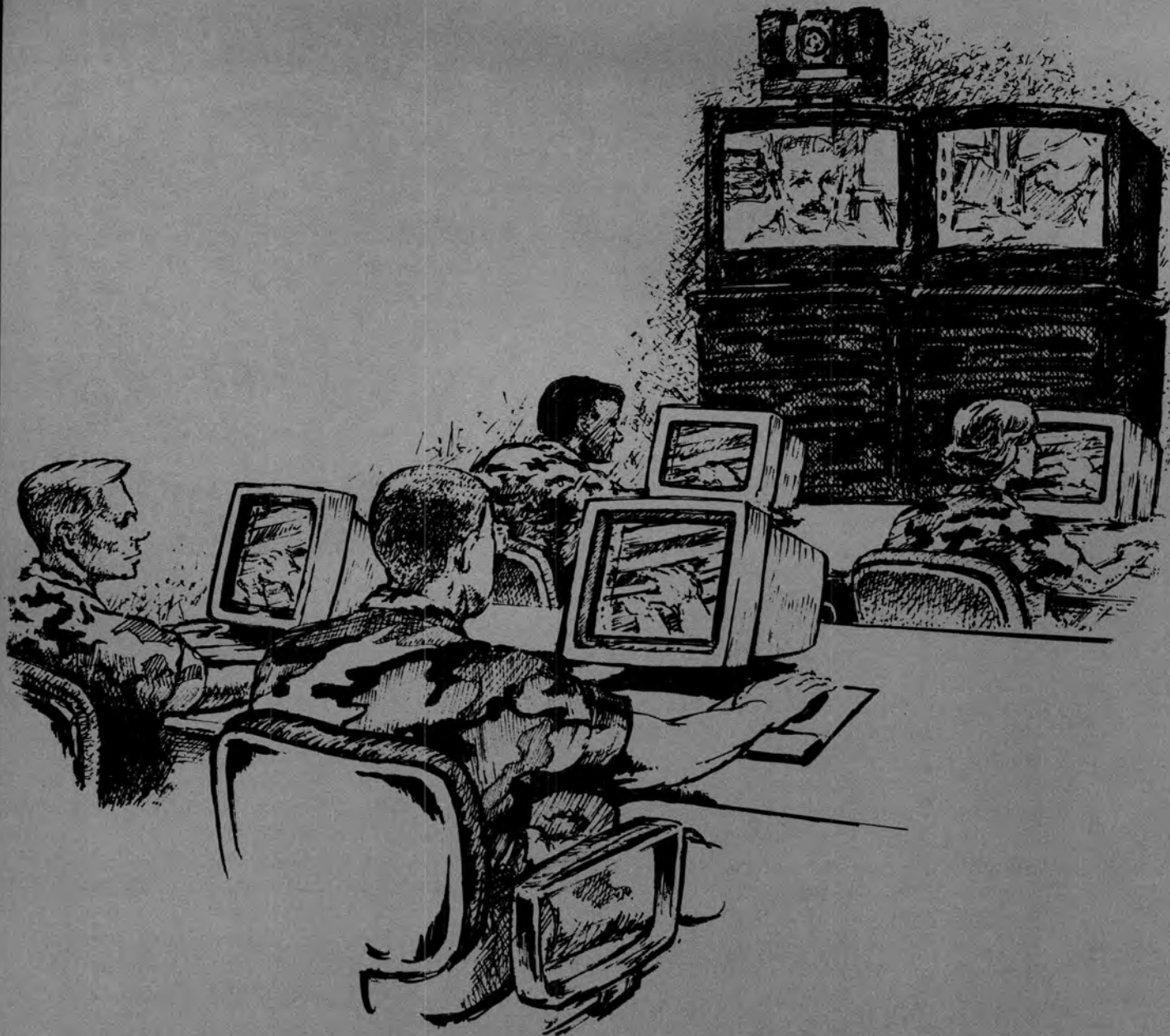

Headquarters, Department of the Army
This publication is approved for public release. Distribution is unlimited.

PIN : 076805 000